

Pioneer

Owner's Manual

DVD RDS AV RECEIVER

AVH-P8400BH



DLX



HD Radio[®]

This HD Radio receiver enables:

PSD)

HD2/HD3)

Digital Sound)

iTunes[®] Tagging)

English

Thank you for purchasing this PIONEER product.

To ensure proper use, please read through this manual before using this product. It is especially important that you read and observe **WARNING**s and **CAUTION**s in this manual. *Please keep the manual in a safe and accessible place for future reference.*



Be sure to read this

- DVD video disc region numbers **8**
- Handling guidelines **100**

01 Precautions

IMPORTANT SAFEGUARDS **5**

To ensure safe driving **5**

To avoid battery exhaustion **6**

02 Before you start

Information to User **7**

The Safety of Your Ears is in Your Hands **7**

About this unit **8**

About this manual **8**

Operating environment **9**

After sales service for Pioneer products **9**

Visit our website **9**

Adjusting the response positions of the touch panels (Touch Panel Calibration) **9**

Use and care of the remote control **9**

03 What's what

Head unit **11**

Remote control **12**

04 Basic operations

Basic operations **14**

USB/iPod1 and USB/iPod2 **16**

Operating the scroll icon and the scrubber bar **16**

Activating the touch panel keys **17**

Common operations for menu settings/lists **17**

Adjusting the LCD panel angle **17**

Ejecting a disc **17**

Ejecting an SD **18**

Removing the front panel **18**

Attaching the front panel **18**

Setting the clock **19**

Resetting the microprocessor **19**

Demo mode **19**

05 HD Radio™ tuner

About HD Radio™ broadcasting **20**

Introduction of HD Radio tuner operations **20**

06 XM/SIRIUS tuner

Introduction of XM/SIRIUS tuner operations **22**

07 Playing moving images

Introduction of video playback operations **24**

08 Playing audio

Introduction of sound playback operations **27**

09 Advanced App Mode

Introduction of Advanced App Mode operation **31**

10 Using MIXTRAX

Introduction of MIXTRAX operation **33**

Introduction of MIXTRAX EZ operation **33**

11 Using Pandora® internet radio

Pandora operations **34**

12 Playing still images

Introduction of still image playback operations **36**

13 Bluetooth telephone

Introduction of Bluetooth telephone operations **38**

14 Detailed instructions

Storing and recalling stations **40**

Storing the strongest stations **40**

- Tuning in to strong signals **40**
 - Using iTunes tagging **40**
 - Switching the media file type **41**
 - Operating the DVD menu **41**
 - Operating this unit's iPod function from your iPod **42**
 - Random play (shuffle) **42**
 - Repeating playback **42**
 - Playing videos from your iPod **43**
 - Playing videos from USB storage device and SD **43**
 - Selecting and playing Pandora® stations/QuickMix **43**
 - Browsing for a video/music on the iPod **44**
 - Resume playback (Bookmark) **45**
 - Frame by frame playback **45**
 - Slow motion playback **45**
 - Searching for the part you want to play **45**
 - Changing audio language during playback (Multi audio) **46**
 - Changing the subtitle language during playback (Multi subtitle) **46**
 - Changing the viewing angle during playback (Multi angle) **46**
 - Return to the specified scene **46**
 - Selecting audio output **46**
 - PBC playback **47**
 - Selecting tracks from the track title list **47**
 - Selecting files from the file name list **47**
 - Using sound retriever **47**
 - Changing audiobook speed **47**
 - Displaying lists related to the currently playing song (Link Search) **47**
 - Setting the Advanced Display Resolution **48**
 - Music Browse mode **48**
 - Playing DivX® VOD content **48**
 - Capture an image in JPEG files **49**
 - Changing the wide screen mode **49**
 - Switching the XM/SIRIUS channel selection mode **49**
 - Selecting an XM/SIRIUS channel directly **50**
 - Using the Game Alert function **50**
 - Displaying the Radio ID **51**
 - Switching the SIRIUS display **52**
 - Using the Instant Replay function **52**
 - Switching the seek mode **52**
 - Switching the reception mode **52**
 - Calling a number in the phone book **52**
 - Selecting a number by alphabet search mode **53**
 - Inverting names in phone book **53**
 - Using the missed, received and dialed call lists **53**
 - Setting automatic answering **54**
 - Adjusting the other party's listening volume **54**
 - Switching the ring tone **54**
 - Using the preset dial lists **54**
 - Making a call by entering phone number **55**
 - Setting the private mode **55**
- 15 Menu operations**
- Introduction of menu operations **56**
 - Audio adjustments **57**
 - Setting up the Video player **60**
 - System settings **64**
 - Favorite menu **70**
 - Introduction of Bluetooth connection menu operations **71**
 - Introduction of Theme setting menu operations **73**
- 16 Other functions**
- Setting rear monitor output **75**
 - Adjusting the response positions of the touch panels (Touch Panel Calibration) **75**
 - Using an AUX source **75**

Using an external unit **76**

17 Installation

Connecting the units **78**

Installation **88**

● Additional information

Troubleshooting **91**

Error messages **93**

Understanding auto EQ error messages **97**

Understanding messages **97**

Indicator list **98**

Handling guidelines **100**

Compressed audio compatibility (disc, USB,
SD) **103**

iPod compatibility **104**

Sequence of audio files **104**

Using the display correctly **105**

Bluetooth profiles **106**

Copyright and trademark **106**

Language code chart for DVD **110**

Specifications **111**

Precautions

IMPORTANT SAFEGUARDS

Please read all of these instructions regarding your display and retain them for future reference.

- 1 **Read this manual fully and carefully before operating your display.**
- 2 **Keep this manual handy as a reference for operating procedures and safety information.**
- 3 **Pay close attention to all warnings in this manual and follow the instructions carefully.**
- 4 **Do not allow other persons to use this system until they have read and understood the operating instructions.**
- 5 **Do not install the display where it may (i) obstruct the driver's vision, (ii) impair the performance of any of the vehicle's operating systems or safety features, including air bags, hazard lamp buttons or (iii) impair the driver's ability to safely operate the vehicle.**
- 6 **Do not operate this display if doing so in any way will divert your attention from the safe operation of your vehicle. Always observe safe driving rules and follow all existing traffic regulations. If you experience difficulty in operating the system or reading the display, park your vehicle in a safe location and make necessary adjustments.**
- 7 **Please remember to wear your seat belt at all times while operating your vehicle. If you are ever in an accident, your injuries can be considerably more severe if your seat belt is not properly buckled.**
- 8 **Never use headphones while driving.**
- 9 **To promote safety, certain functions are disabled unless the parking brake is on, and the vehicle is not in motion.**
- 10 **Never set the volume of your display so high that you cannot hear outside traffic and emergency vehicles.**



WARNING

Do not attempt to install or service your display by yourself. Installation or servicing of the display by persons without training and experience in electronic equipment and automotive accessories may be dangerous and could expose you to the risk of electric shock or other hazards. ■

To ensure safe driving



WARNING

- **LIGHT GREEN LEAD AT POWER CONNECTOR IS DESIGNED TO DETECT PARKED STATUS AND MUST BE CONNECTED TO THE POWER SUPPLY SIDE OF THE PARKING BRAKE SWITCH. IMPROPER CONNECTION OR USE OF THIS LEAD MAY VIOLATE APPLICABLE LAW AND MAY RESULT IN SERIOUS INJURY OR DAMAGE.**
- To avoid the risk of damage and injury and the potential violation of applicable laws, this unit is not for use with a video screen that is visible to the driver.
- To avoid the risk of accident and the potential violation of applicable laws, no viewing of front seat video should ever occur while the vehicle is being driven.
- In some countries or states the viewing of images on a display inside a vehicle even by persons other than the driver may be illegal. Where such regulations apply, they must be obeyed and this unit's video features should not be used.

When you attempt to watch a video image while driving, the warning "**Viewing of front seat video source while driving is strictly prohibited.**" will appear on the front display. To watch a video image on the front display, park your vehicle in a safe place and apply the parking brake.

Parking brake interlock

Certain functions (Video viewing and certain touch panel keys) offered by this unit could be dangerous and/or unlawful if used while driving. To prevent such functions from being used while the vehicle is in motion, there is an interlock system that senses when the parking brake is set. If you attempt to use the functions described above while driving, they will be come disabled until you stop the vehicle in a safe place, and (1) apply the parking brake, (2) release the parking brake, and then (3) apply the parking brake again. Please keep the brake pedal pushed down before releasing the parking brake.

When using a display connected to V OUT

This unit's **V OUT** is for connection of a display to enable passengers in the rear seats to watch videos.



WARNING

NEVER install the rear display in a location where the driver can watch videos while driving.

When using the rear view camera

With an optional rear view camera, this unit can be used as an aid to keep an eye on trailers, or when backing into a tight parking spot.



WARNING

- **SCREEN IMAGE MAY APPEAR REVERSED.**
- **USE INPUT ONLY FOR REVERSE OR MIRROR IMAGE REAR VIEW CAMERA. OTHER USE MAY RESULT IN INJURY OR DAMAGE.**



CAUTION

- The rear view camera function is to be used as an aid to keep an eye on trailers, or while

backing up. Do not use for entertainment purposes.

- Please note that the edges of the rear view camera images may differ slightly according to whether full screen images are displayed when backing up, and whether the images are used for checking the rear when the vehicle is moving forward. 

To avoid battery exhaustion

Keep the vehicle engine running when using this unit to avoid draining the battery power.

- When no power is supplied to this unit, such as when the vehicle battery is being replaced, the microcomputer of this unit returns to its initial condition. We recommend that you transcribe the audio adjustment data.



WARNING

Do not use with vehicles that do not feature an ACC position. 

Before you start

FCC ID: AJDK048

MODEL NO.: AVH P8400BH

IC: 775E K048

This device complies with Part 15 of FCC Rules and Industry Canada licence exempt RSS standard(s). Operation is subject to the following two conditions: (1) this device may not cause interference, and (2) this device must accept any interference, including interference that may cause undesired operation of this device. This transmitter must not be co located or operated in conjunction with any other antenna or transmitter.

The antenna for Bluetooth cannot be removed (or replaced) by user.

This equipment complies with FCC/IC radiation exposure limits set forth for an uncontrolled environment and meets the FCC radio frequency (RF) Exposure Guidelines in Supplement C to OET65 and RSS 102 of the IC radio frequency (RF) Exposure rules. This equipment has very low levels of RF energy that it deemed to comply without maximum permissive exposure evaluation (MPE). But it is desirable that it should be installed and operated keeping the radiator at least 20 cm or more away from person's body (excluding extremities: hands, wrists, feet and ankles).

Note

This equipment has been tested and found to comply with the limits for a Class B digital device, pursuant to Part 15 of the FCC Rules. These limits are designed to provide reasonable protection against harmful interference in a residential installation. This equipment generates, uses and can radiate radio frequency energy and, if not installed and used in accordance with the instructions, may cause harmful interference to radio communications. However, there is no guarantee that interference will not occur in a particular installation. If this equipment does cause harmful interference to radio or television reception, which can be determined by turning the equipment off and on, the user is encouraged to try to correct the interference by one or more of the following measures:

- Reorient or relocate the receiving antenna.

- Increase the separation between the equipment and receiver.

- Connect the equipment into an outlet on a circuit different from that to which the receiver is connected.

- Consult the dealer or an experienced radio/TV technician for help.



Information to User

Alteration or modifications carried out without appropriate authorization may invalidate the user's right to operate the equipment.

The Safety of Your Ears is in Your Hands

Get the most out of your equipment by playing it at a safe level – a level that lets the sound come through clearly without annoying blaring or distortion and, most importantly, without affecting your sensitive hearing. Sound can be deceiving. Over time, your hearing “comfort level” adapts to higher volumes of sound, so what sounds “normal” can actually be loud and harmful to your hearing. Guard against this by setting your equipment at a safe level BEFORE your hearing adapts.

Before you start

ESTABLISH A SAFE LEVEL:

- Set your volume control at a low setting.
- Slowly increase the sound until you can hear it comfortably and clearly, without distortion.
- Once you have established a comfortable sound level, set the dial and leave it there.

BE SURE TO OBSERVE THE FOLLOWING GUIDELINES:

- Do not turn up the volume so high that you can't hear what's around you.
- Use caution or temporarily discontinue use in potentially hazardous situations.
- Do not use headphones while operating a motorized vehicle; the use of headphones may create a traffic hazard and is illegal in many areas. 

About this unit

The tuner frequencies on this unit are allocated for use in North America. Use in other areas may result in poor reception.

WARNING

Handling the cord on this product or cords associated with accessories sold with the product may expose you to chemicals listed on proposition 65 known to the State of California and other governmental entities to cause cancer and birth defect or other reproductive harm. **Wash hands after handling.**

CAUTION:
USE OF CONTROL OR ADJUSTMENT OR PERFORMANCE OF PROCEDURES OTHER THAN THOSE SPECIFIED HEREIN MAY RESULT IN HAZARDOUS RADIATION EXPOSURE.

CAUTION:
THE USE OF OPTICAL INSTRUMENTS WITH THIS PRODUCT WILL INCREASE EYE HAZARD.

CAUTION

- Do not allow this unit to come into contact with liquids. Electrical shock could result. Also, damage to this unit, smoke, and over heating could result from contact with liquids.
- Keep this manual handy for future reference.
- Always keep the volume low enough to hear outside sounds.
- Avoid exposure to moisture.
- If the battery is disconnected or discharged, any preset memory will be erased.

Important (Serial number)

The serial number is located on the bottom of this unit. For your own security and convenience, be sure to record this number on the enclosed warranty card.

DVD video disc region numbers

Only DVD video discs with compatible region numbers can be played on this player. You can find the region number of the player on the bottom of this unit and in this manual (refer to *Specifications* on page 111). 

About this manual

This unit features a number of sophisticated functions to ensure superior reception and operation. All the functions have been designed for the easiest possible use, but many are not self explanatory. This operation manual will help you benefit fully from this unit's potential and to maximize your listening enjoyment. We recommend that you familiarize yourself with the functions and their operation by reading through the manual before you begin using this unit. It is especially important that you read and observe **WARNINGs** and **CAUTIONs** in this manual. 

Before you start

Operating environment

This unit should be used within the temperature ranges shown below.

Operating temperature range: 14°F to 140°F
EN300328 ETC test temperature: -4°F and 131°F

After-sales service for Pioneer products

Please contact the dealer or distributor from where you purchased this unit for after sales service (including warranty conditions) or any other information. In case the necessary information is not available, please contact the companies listed below:

Please do not ship your unit to the companies at the addresses listed below for repair without advance contact.

U.S.A.

Pioneer Electronics (USA) Inc.
CUSTOMER SUPPORT DIVISION
P.O. Box 1760
Long Beach, CA 90801 1760
800 421 1404

CANADA

Pioneer Electronics of Canada, Inc.
CUSTOMER SATISFACTION DEPARTMENT
340 Ferrier Street
Unit 2
Markham, Ontario L3R 2Z5, Canada
1 877 283 5901
905 479 4411

For warranty information please see the Limited Warranty sheet included with this unit.

Visit our website

Visit us at the following site:

<http://www.pioneerelectronics.com>
in Canada

<http://www.pioneerelectronics.ca>

- 1 Register your product. We will keep the details of your purchase on file to help you refer to this information in the event of an insurance claim such as loss or theft.
- 2 Receive updates on the latest products and technologies.
- 3 Download owner's manuals, order product catalogues, research new products, and much more.
- 4 Your feedback is important in our continual effort to design and build the most advanced, consumer focused product in the industry.

Serial number



Adjusting the response positions of the touch panels (Touch Panel Calibration)

If you feel that the touch panel keys on the screen deviate from the actual positions that respond to your touch, adjust the response positions of the touch panel. Refer to *Adjusting the response positions of the touch panels (Touch Panel Calibration)* on page 75.

Use and care of the remote control

Installing the battery

Slide the tray on the back of the remote control out and insert the battery with the plus (+) and minus (-) poles aligned properly.

- When using for the first time, pull out the film protruding from the tray.

Before you start

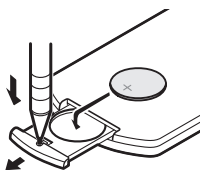

- Do not let the remote control fall onto the floor, where it may become jammed under the brake or accelerator pedal. 

WARNING

- Keep the battery out of the reach of children. Should the battery be swallowed, consult a doctor immediately.
- Batteries (battery pack or batteries installed) must not be exposed to excessive heat such as sunshine, fire or the like.

CAUTION

- Use one **CR2025 (3 V)** lithium battery.
- Remove the battery if the remote control is not used for a month or longer.
- There is a danger of explosion if the battery is incorrectly replaced. Replace only with the same or equivalent type.
- Do not handle the battery with metallic tools.
- Do not store the battery with metallic objects.
- If the battery leaks, wipe the remote control completely clean and install a new battery.
- When disposing of used batteries, comply with governmental regulations or environmental public institutions' rules that apply in your country/area.
- "Perchlorate Material special handling may apply.
See www.dtsc.ca.gov/hazardouswaste/perchlorate. (Applicable to California, U.S.A.)"

Using the remote control

Point the remote control in the direction of the front panel to operate.

- The remote control may not function properly in direct sunlight.

Important

- Do not store the remote control in high temperatures or direct sunlight.

What's what

Head unit

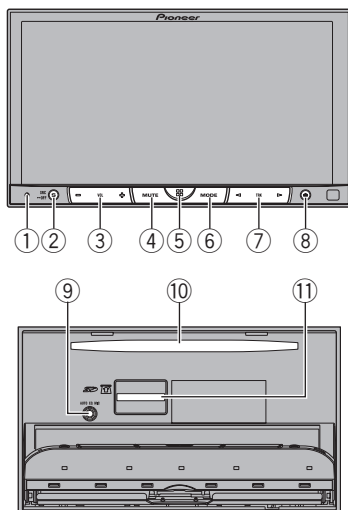

Part	Part
① RESET	⑦ ◀▶ (TRK) ▲ (eject) Refer to <i>Ejecting a disc</i> on page 17. Refer to <i>Ejecting an SD</i> on page 18.
② SRC/OFF	⑧ Refer to <i>Adjusting the LCD panel angle</i> on page 17. Refer to <i>Removing the front panel</i> on page 18.
③ +/- (VOLUME/VOL)	⑨ Auto EQ micro phone input jack Use to connect an auto EQ micro phone.
④ MUTE	⑩ Disc loading slot

Part

Part

HOME

Displaying the **HOME** display.
The display returns to the Launcher screen while a 3rd party application is being used in Advanced App Mode. Doubleclicking the icon on the Launcher screen returns the display to the **HOME** display.

⑤

⑪ SD memory card slot

MODE

⑥ Turning the information display off.

! CAUTION

- Do not use unauthorized products.
- When inserting an SD card into the card slot, make sure that the label is facing up and press the card until it clicks and completely locks into place.

Notes

- When the navigation system is connected, press **MODE** to switch to the navigation display. Press **MODE** and hold to turn the display off.
Press **MODE** again to turn the display on.
- For details on how to operate a navigation system from this unit, refer to its operation manual.
- When an iPhone that is running an application that supports Advanced App Mode is connected, press **MODE** to switch to the application display. You can use the application by touching the display.
- About the way to connect the USB portable audio player/USB memory to this unit, refer to *When connecting with optional CD IU201V cable* on page 84. ■

Remote control

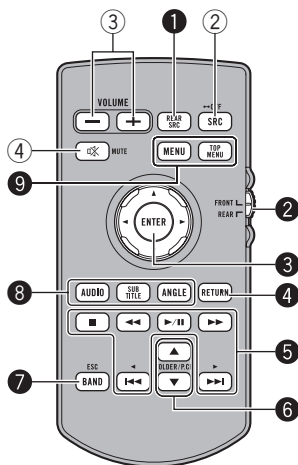

Part	Operation
1 REAR SRC	Press to cycle through all the available rear sources. Press and hold to turn the rear source off.
2 Source mode select switch	Use to switch the source mode between the front source and the rear source.
3 Thumb pad	Use to select a menu on the DVD menu.
4 RETURN	Press to display the PBC (playback control) menu during PBC playback.

Part	Operation
▶/	Press to pause or resume playback.
◀◀	Press to perform fast reverse. Press to change the fast reverse speed.
▶▶	Press to perform fast forward. Press to change the fast forward speed.
◀◀	Press to return to the previous track (chapter).
▶▶	Press to go to the next track (chapter).
■	Press to stop playback. If you resume playback, playback will start from the point where you stopped. Touch the key again to stop playback completely.
▲/▼(FOLDER/P.CH)	Press to select the next/previous disc/folder. Press to recall radio station frequencies as signed to preset tuning keys.
7 BAND/ESC	Press to select the tuner band when tuner is selected as a source. Also used to cancel the control mode of functions. Press to switch between modes when playing from discs or external storage devices(USB, SD) with compressed audio and audio data (CD DA) such as with CD EXTRA and MIXED MODE CDs.

What's what

Part	Operation
AUDIO	Press to change the audio language during DVD playback. Press to switch audio output for DivX/MPEG 4.
8 SUBTITLE	Press to change the subtitle language during DVD/DivX/MPEG 4 playback.
ANGLE	Press to change the viewing angle during DVD playback.
MENU	Press to display the DVD menu during DVD playback.
9 TOP MENU	Press to return to the top menu during DVD playback.



Basic operations

HOME display (Front)

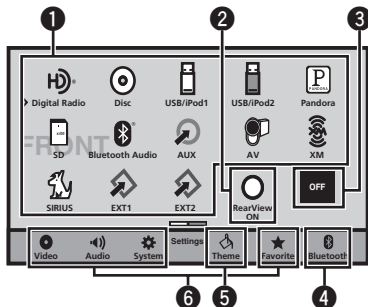

HOME display (Rear)

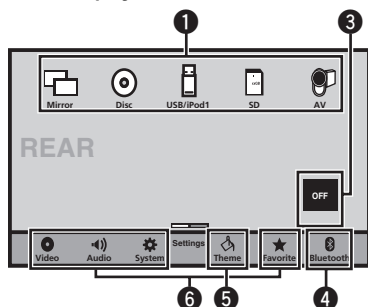

Flick/drag the icon to switch between Front and Rear for **HOME** display. Make sure to touch the display to flick/drag them. The following section describes how to switch the output source for the rear monitor. Refer to *Setting rear monitor output* on page 75.

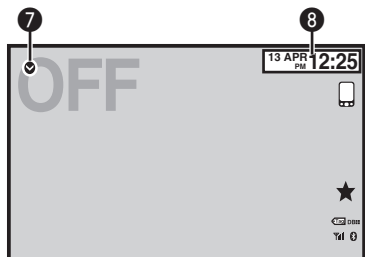

Source off display



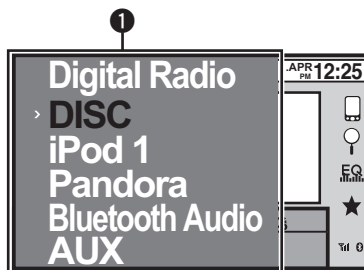

Source on display







Touch panel keys

1	 Digital Radio	Source icon Selecting a favorite source. When the source icon is not displayed, it can be displayed by pressing the home key or touching  .
---	--	---

Displaying the rear view image by turning the rear view image on. When the rear view image is displayed, you can switch to the source display by touching the display. You can operate from the source display temporarily at this time. If you do not perform any operations within a few seconds, the display will return to the rear view image. To turn off the rear view image, press **HOME** to return to the **HOME** display and then press the touch key again. This unit can be setup to display the rear view image automatically when you move the shift lever to the **REVERSE (R)** position. For details about the settings, refer to *Setting the rear view camera (back up camera)* on page 66.

2	 RearView ON	
3	 OFF	Turning the source off.

Basic operations

4		Displaying the Bluetooth connection menu. Refer to <i>Introduction of Bluetooth connection menu operations</i> on page 71.
5		Displaying the Theme menu. Refer to <i>Introduction of Theme setting menu operations</i> on page 73.
6		Displaying the menu. Refer to <i>Menu operations</i> on page 56.
7		Displaying the source menu.
8		Switching to clock adjustment display. Refer to <i>Setting the clock</i> on page 19.

Switching to HOME display 1 Press HOME when you want to switch the display.
Turning the source on using the buttons 1 Press SRC/OFF to turn the source on.
Turning the source off using the buttons 1 Press SRC/OFF and hold until the source turns off.

Selecting a source using the buttons
 1 Press **SRC/OFF** to cycle through the sources listed below:

Selecting a source using the touch panel keys

1 Touch the source icon and then touch the desired source name.

- **XM** XM tuner
- **SIRIUS** SIRIUS tuner
- **Radio** Built in Digital Radio tuner
- **Disc** Built in DVD player
- **USB/iPod 1** USB/iPod 1
- **USB/iPod 2** USB/iPod 2
- **Pandora** Pandora® internet radio
- **SD** SD memory card
- **Bluetooth Audio** Built in Bluetooth audio
- **AUX** AUX
- **AV** AV input
- **EXT 1** External unit 1
- **EXT 2** External unit 2
- When the source icon is not displayed, it can be displayed by touching the screen.
- While operating the menu, you cannot select a source by touching the source icon.

Adjusting the volume

1 Press **+/- (VOLUME/VOL)** to adjust the volume.

Notes

- In this manual, iPod and iPhone will be referred to as "iPod".
- The **USB/iPod 1** or **USB/iPod 2** icon will change as follows:
 - USB 1** is displayed when a USB storage device is connected to USB input 1.
 - iPod 1** is displayed when an iPod is connected to USB input 1.
 - USB 2** is displayed when a USB storage device is connected to USB input 2.
 - iPod 2** is displayed when an iPod is connected to USB input 2.
 - STEEZ** is displayed when a **STEEZ PORTABLE** (Pioneer product) is connected to USB input 1 or USB input 2.
 - USB/iPod 1** or **USB/iPod 2** is displayed when no device is connected.

Basic operations

- An external unit refers to a Pioneer product, such as those which will be available in the future. Although incompatible as a source, the basic functions of up to two external units can be controlled with this unit. When two external units are connected, the external units are automatically allocated to external unit 1 or external unit 2.

USB/iPod 1 and USB/iPod 2

This unit has **USB/iPod 1** and **USB/iPod 2** sources.

In **USB/iPod 2**, the following functions are not available.

- Pandora
- Advanced App Mode
- Rear monitor output

- ① Scroll icon
Appears when selectable items are hidden.
- ② Scrubber bar
Appears when items cannot be displayed on a single page only.

Viewing the hidden items

- ① Touch the scroll icon or drag the scrubber bar to view any hidden items.
 - Also, you can drag the list to view any hidden items.

Specifying the playback point

- ① Drag the scrubber bar on the screen.
(Not available when the scrubber bar is grayed out.)



Operating the scroll icon and the scrubber bar

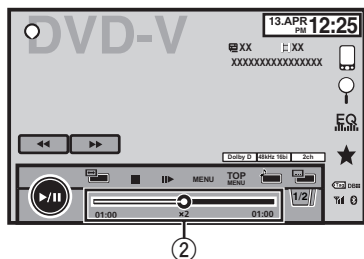
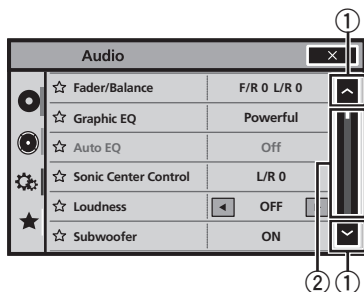

Basic operations

Activating the touch panel keys

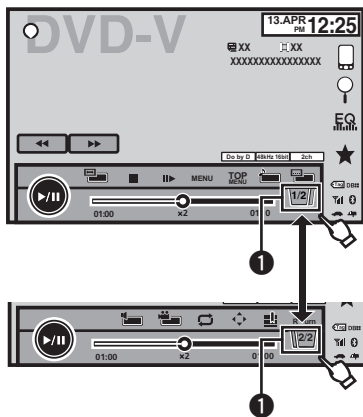

Touch panel keys



Switching the touch keys on the display.

Common operations for menu settings/lists

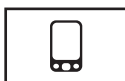

Starting the Bluetooth telephone menu.
Refer to *Introduction of Bluetooth telephone operations* on page 38.



Displaying the list menu.
Starting the search function.



Displaying the EQ (Audio function menu).
Refer to *Using the equalizer* on page 57.



Displaying the Favorite menu.
Refer to *Favorite menu* on page 70.

Adjusting the LCD panel angle

⚠ CAUTION

Keep hands and fingers clear of the unit when opening, closing, or adjusting the LCD panel. Be especially cautious of children's hands and fingers.

1 Press ▲(eject) to display the ejecting menu.

2 Adjust the LCD panel to an easily viewable angle.



Laying the panel down.



Returning the panel to the upright position.

- As the set angle is saved, the LCD panel will automatically be adjusted to the same position the next time the LCD panel is opened. □

Ejecting a disc

⚠ CAUTION

Keep hands and fingers clear of the unit when opening, closing, or adjusting the LCD panel. Be especially cautious of children's hands and fingers.

1 Press ▲(eject) to display the ejecting menu.

2 Eject a disc.



Ejecting a disc.



Ejecting an SD

1 Press **▲**(eject) to display the ejecting menu.

2 Eject an SD.



Ejecting an SD.

3 Press an SD to eject. 

Removing the front panel

CAUTION

- Do not attempt to detach the front panel while DISC/SD is in the eject position.
- Do not attempt to detach the front panel while data is being written to USB/SD. Doing so may cause the data to become corrupted.
- After the front panel has been detached, the attaching plate will move back to its original position automatically. Be careful not to let hands or other objects get caught behind the monitor as it is moving back.
- Please make sure that the front panel is in its original position while the vehicle is in motion. It is dangerous to drive with the front panel sticking out.
- Do not place beverages or other objects on top of the front panel while it is fully open.

Important

- Handle gently when removing or attaching the front panel.

- Avoid subjecting the front panel to excessive shock.
- Keep the front panel out of direct sunlight and high temperatures.
- If removed, replace the front panel on the unit before starting up your vehicle.

1 Press **▲** (eject) to release the front panel.

2 Touch the detach key.



The front panel automatically slides toward you.

3 Slide the dial at the bottom of the front panel to the right, and lift up the front panel while pushing down on the dial.

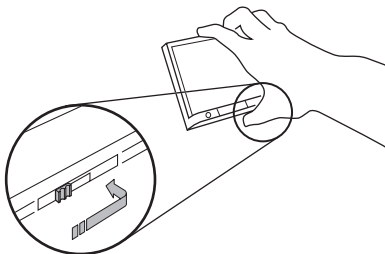

4 Put the front panel into the provided protective case for safe keeping. 

Attaching the front panel

1 Slide the front panel into the top of the unit and push it into place.

Slide the inserter on the front panel into the in section slot on top of the unit and push it into place.

Basic operations

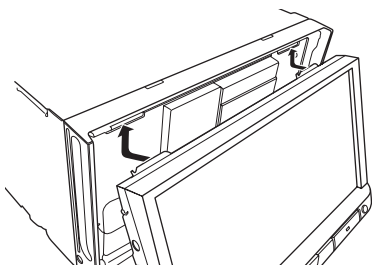

- 2 Push on the bottom of the front panel until it clicks into place.**

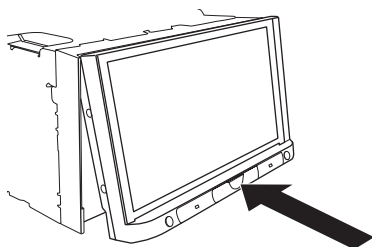

Setting the clock

- 1 Switch to Clock Adjustment display.**
Refer to *Basic operations* on page 14.
- 2 Select the item to set.**
- 3 Touch ▲ or ▼ to set the correct date and time.** 

Resetting the microprocessor

By pressing **RESET**, you can reset the microprocessor to its initial settings without changing the bookmark information.

The microprocessor must be reset in the following situations:

- Before using this unit for the first time after installation
- If the unit fails to operate properly

- When strange or incorrect messages appear on the display

- 1 Turn the ignition switch OFF.**
- 2 Press RESET with a pen tip or other pointed instrument.**

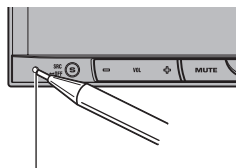

RESET button

Note

Switch your engine ON or set the ignition switch to ACC ON before pressing **RESET** in the following situations:

- After completing connections
- When erasing all stored settings
- When resetting the unit to its initial (factory) settings 

Demo mode

The feature demo automatically starts when you select **Off** for the source and continues while the ignition switch is set to ACC or ON. To cancel the feature demo, press and hold **MUTE**. Press and hold **MUTE** again to restart. Operating the feature demo while the car engine is turned off it may drain the battery power.

Important

Failure to connect the red lead (ACC) of this unit to a terminal coupled with ignition switch on/off operations may lead to battery drain. 

About HD Radio™ broadcasting

HD Radio™ broadcasting is high quality audio and data services. HD Radio broadcasting is brought to you by your local FM/AM stations. HD Radio broadcasting features the following:

- High quality audio
- FM multicasting
- Data services

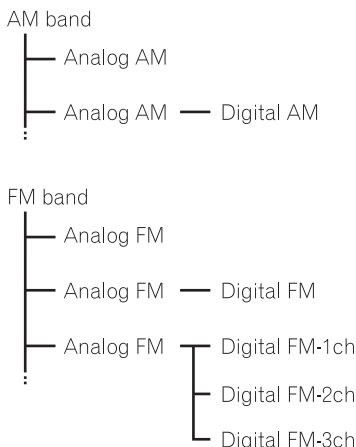

PSD

Program Service Data: Contributes to the superior user experience of HD Radio Technology. Presents song name, artist, station IDs, HD2/HD3 Channel Guide, and other relevant data streams.

HD2/HD3

Adjacent to traditional main stations are extra local FM channels. These HD2/HD3 Channels provide new, original music as well as deep cuts into traditional genre.

Digital Sound

Digital, CD quality sound. HD Radio Technology enables local radio stations to broadcast a clean digital signal. AM sounds like today's FM and FM sounds like a CD.

iTunes® Tagging

iTunes® Tagging provides you the opportunity to discover a wide range of content and the means to "tag" that content for later review and purchase from the iTunes® Store.



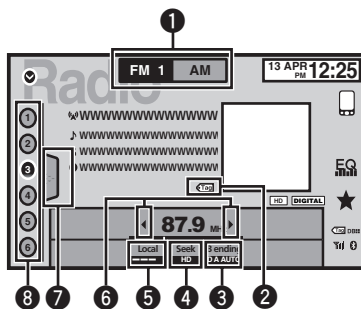

Introduction of HD Radio tuner operations

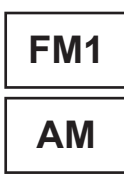

Touch panel keys

- 

Selecting a band (FM or AM) by touching the band key. The touch panel key for the selected band is highlighted. Switching between **FM1**, **FM2**, and **FM3** by touching the band key. When **AM** is selected, you cannot switch to another **AM** band by touching the band key.
- 

Saving song information (tag) from the broadcasting station to your iPod. Refer to *Using iTunes tagging* on page 40.
- 

Switching to the analog broadcast of the same frequency. Refer to *Switching the reception mode* on page 52.

HD Radio™ tuner

4

Seek

ALL

Seek

HD

Switching between Digital broadcasting station seek and normal seek.
Refer to *Switching the seek mode* on page 52.

5

Local

Setting the local seek level.
Refer to *Tuning in to strong signals* on page 40.

Tuning up or down manually. Touch and hold for more than two seconds to skip stations. Seek tuning starts as soon as you release. Touch again to cancel seek tuning.

- When an analog station is received, tuning down operation is conducted with in the analog broadcasting. (⑥ → ②)
- If a digital broadcast is not yet received, tuning up operation tunes in the next analog station. (② → ⑥)

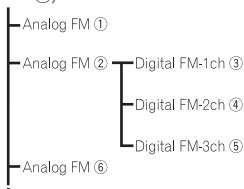
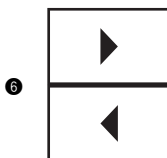

7

Displaying the preset channel list.
Refer to *Storing and recalling stations* on page 40.

8

Refer to *Storing the strongest stations* on page 40.

9

Select a preset channel.

Switching preset channels using the buttons

1 Press ◀ or ▶ (TRK).

Seek tuning using the buttons

1 Press and hold ◀ or ▶ (TRK).

Note

Touch panel keys not listed under *Introduction of HD Radio tuner operations* may appear on the display.

Refer to *Indicator list* on page 98. ■

Introduction of XM/SIRIUS tuner operations

SIRIUS tuner

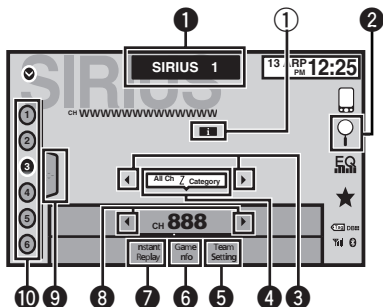

XM tuner

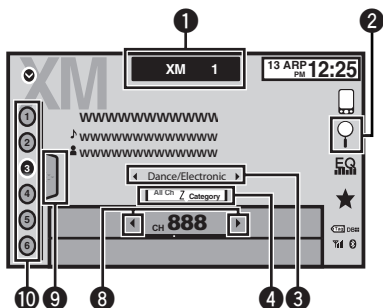

You can use this unit to control an XM satellite digital tuner (GEX P920XM), which is sold separately.

You can use this unit to control a SIRIUS Satellite Radio tuner, which is sold separately.

For details concerning operation, refer to the XM tuner's operation manuals. This section provides information on XM operations with this unit which differs from that described in the XM tuner's operation manual.

When the SIRIUS tuner is used together with this unit, some operations differ slightly from those described in the SIRIUS operation manual. This manual provides information on these points. For all other information on using the SIRIUS tuner, please refer to the SIRIUS operation manual.

- With this unit, you can operate one additional function: XM/SIRIUS channel direct selection. Refer to *Selecting an XM/SIRIUS channel directly* on page 50.

Touch panel keys

1		Selecting a band (XM1 , XM2 or XM3) for XM tuner. Selecting a band (SIRIUS1 , SIRIUS2 or SIRIUS3) for the SIRIUS tuner.
		Displaying the preset channel list. Refer to <i>Storing and recalling stations</i> on page 40.
2		Selecting a channel directly. Refer to <i>Selecting an XM/SIRIUS channel directly</i> on page 50.
		Selecting a channel from the XM channel list. Refer to <i>Selecting a channel from the XM channel list display</i> on page 50.
3		Selecting a channel or category. Refer to <i>Switching the XM/SIRIUS channel selection mode</i> on page 49.
4		Selecting a channel category.
5		Selecting teams for game alert on the SIRIUS tuner. Refer to <i>Selecting teams for Game Alert</i> on page 50.
6		Displaying information on games for the SIRIUS tuner. Refer to <i>Displaying game information</i> on page 51.
7		Selecting a track, fast for warding/reversing or pausing/playing for the SIRIUS tuner. Refer to <i>Using the Instant Replay function</i> on page 52.

XM/SIRIUS tuner

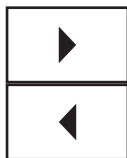

8

Recalling radio station frequencies assigned to preset tuning keys.

Refer to *Storing and recalling stations* on page 40.

Selecting the channel category when selecting **Mode Category**.

Refer to *Switching the XM/SIRIUS channel selection mode* on page 49 and *Selecting a SIRIUS channel from a channel category* on page 50.

9

Displaying the preset channel list.

Refer to *Storing and recalling stations* on page 40.

10

Recalling the preset channels by touching the key.

Storing the current station in the preset channel list by touching and holding the key.

SIRIUS tuner information

Switching the SIRIUS information.

Refer to *Switching the SIRIUS display* on page 52.

①

Touch and hold for more than two seconds to scroll the text.

Manual tuning (step by step) using the buttons

① Press ◀ or ▶ (**TRK**).

Seek tuning using the buttons

① Press and hold ◀ or ▶ (**TRK**).

Notes

- You can also perform tuning from a desired channel category. (Refer to *Selecting a SIRIUS channel from a channel category* on page 50.)
- Touch panel keys not listed under *Introduction of XM/SIRIUS tuner operations* may appear on the display.
Refer to *Indicator list* on page 98. 

Introduction of video playback operations

You can view DVD/DVD R/DVD RW/CD/CD R/CD RW/USB/SD/iPod.

- Depending on your iPod, there may not be any output unless you use CD IU201S/CD IU201V (sold separately). Be sure to use CD IU201S/CD IU201V to connect your iPod.

DVD video

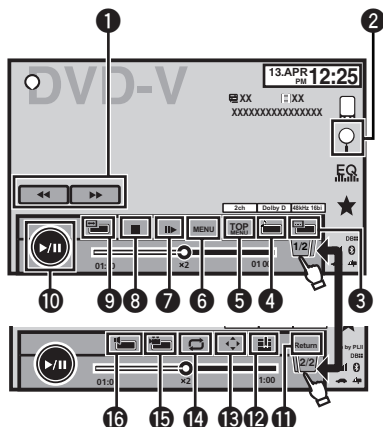

Video CD

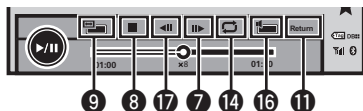

iPod video

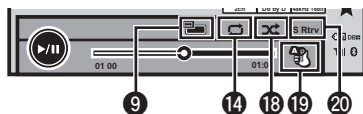

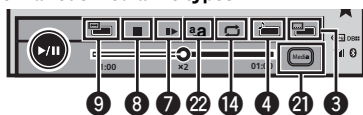

When playing a disc containing a mixture of various media file types



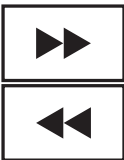

Touch panel keys

- 

Fast forwarding or reversing
Press to change the fast forward and reverse speed.
- 

Starting the search function.
Refer to *Searching for the part you want to play* on page 45.
Refer to *Selecting files from the file name list* on page 47.
Displaying iPod menus.
Refer to *Playing videos from your iPod* on page 43 and *Browsing for a video/music on the iPod* on page 44.
- 

Switching between subtitle languages during playback.
Refer to *Changing the subtitle language during playback (Multi subtitle)* on page 46.
- 















Switching between languages/audio systems during playback.
Refer to *Changing audio language during playback (Multi audio)* on page 46.
- 

Returning to the top menu during DVD playback.
- 

Displaying the DVD menu during DVD playback.
Refer to *Operating the DVD menu* on page 41.
- 

Moving ahead one frame at a time during playback.
Refer to *Frame by frame playback* on page 45.
Touch and hold for more than two seconds to slow down playback speed.
Speeding up the playback speed in four steps during slow motion playback on DVD video/Video CD.

Playing moving images

8		Stopping playback. If you resume playback, play back will start from the point where you stopped. Touch the key again to stop playback completely.
9		Changing the screen mode. Refer to <i>Changing the wide screen mode</i> on page 49.
10		Pausing playback. Returning to normal playback during paused, slow motion, or frame by frame playback.
11		Returning to the specified scene to which the DVD currently being played has been preprogrammed to return. Refer to <i>Return to the specified scene</i> on page 46.
12		During playback, touch the point at which you want to resume playback the next time the disc is loaded. Refer to <i>Resume playback (Bookmark)</i> on page 45.
13		Displaying arrow keys to operate the DVD menu. Refer to <i>Using the arrow keys</i> on page 41.
14		Selecting the repeat range. Refer to <i>Repeating playback</i> on page 42.
15		Switching among viewing angles during playback. Refer to <i>Changing the viewing angle during playback (Multi angle)</i> on page 46.
16		Switching the audio output, when playing video discs recorded with LPCM audio. Refer to <i>Selecting audio output</i> on page 46.
17		Speeding down the playback speed in four steps, during slow motion playback on DVD video/Video CD.
18		Playing the video on your iPod in a random order. Refer to <i>Random play (shuffle)</i> on page 42.
19		Conducting operation from your iPod and listening to it using your car's speakers. Refer to <i>Operating this unit's iPod function from your iPod</i> on page 42.
20		Switching the S.Rtrv (sound retriever) function setting when playing audio. Refer to <i>Using sound retriever</i> on page 47.
21		Switching between media file types to play on DVD/CD/USB/SD. Refer to <i>Switching the media file type</i> on page 41.
22		Adjusting the images on the display. For details, refer to <i>Setting the Advanced Display Resolution</i> on page 48.

Playing moving images

Playing back videos

- 1 Insert the disc into the disc loading slot with the label side up.
Playback will automatically start.
- If you are playing a DVD or Video CD, a menu may appear. Refer to *Operating the DVD menu* on page 41 and *PBC playback* on page 47.
 - When the automatic playback function is on, the unit will skip the DVD menu and automatically start playback from the first chapter of the first title. Refer to *Automatic playback of DVDs* on page 63.
 - While an iPod is connected to this unit, **PIONEER, Accessory Attached** or ✓ (check mark) is displayed on the iPod.
 - When the source icon is not displayed, it can be displayed by touching the screen.
 - Disconnect headphones from the iPod before connecting it to this unit.
 - Depending on the iPod model and the amount of data stored in the iPod, it may take some time for playback to begin.
 - Use the touch panel keys to select the iPod after connecting it to this unit.
 - **No Device** is displayed when disconnecting the iPod.
 - If a message is displayed after loading a disc containing DivX VOD content, touch **Play**. Refer to *Playing DivX® VOD content* on page 48.

Ejecting a disc/SD

- Refer to *Ejecting a disc* on page 17.
- Refer to *Ejecting an SD* on page 18.

Selecting a chapter using the buttons

- 1 Press ◀ or ▶ (**TRK**).

Fast forwarding or reversing using the buttons

- 1 Press and hold ◀ or ▶ (**TRK**).
- Fast forward/fast reverse may not always be possible on some discs. In such cases, normal playback will automatically resume.
 - The fast forward/fast reverse speed depends on the length of time you press and hold down ◀ or ▶ (**TRK**). This function is not available for Video CD.

- Do not insert anything other than a DVD R/RW or CD R/RW into the disc loading slot.
- If the bookmark function is on, DVD playback resumes from the selected point. For more details, refer to *Resume playback (Bookmark)* on page 45.
- Some operations may not be available while watching a media due to the programming of the disc. In such cases, the ⏸ icon appears on the screen.
- To ensure proper operation, connect the dock connector cable from the iPod directly to this unit.
- While the iPod is connected to this unit, the iPod cannot be turned on or off.
- Touch panel keys not listed under *Introduction of video playback operations* may appear on the display.
Refer to *Indicator list* on page 98. ■

Notes

- This DVD player can play back a DivX file recorded on CD R/RW, DVD R/RW, or MPEG 1/MPEG 2/MPEG 4. (Please see the following section for files that can be played back. Refer to *DivX video files* on page 102.)

Playing audio

Introduction of sound playback operations

You can listen to DVD R/DVD RW/CD/CD R/CD RW/USB/SD/iPod sound files.

Audio CD

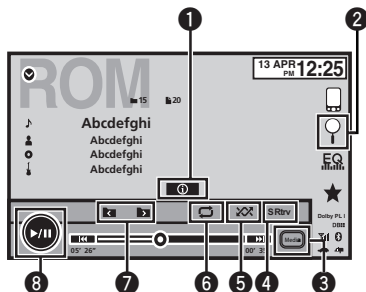

iPod audio (Control Audio)

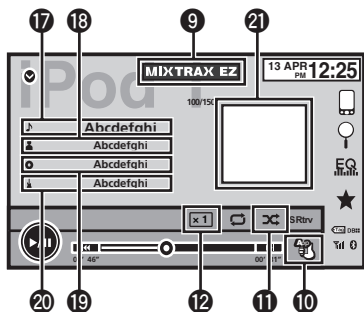

iPod audio (App Mode)

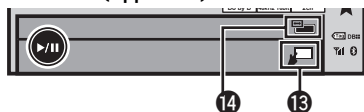

USB/SD audio

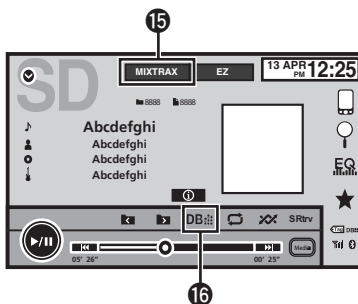

- Depending on your iPod, there may not be any output unless you use CD IU201S/CD IU201V (sold separately). Be sure to use CD IU201S/CD IU201V to connect your iPod.

Bluetooth Audio



















- Depending on the Bluetooth audio player connected to this unit, the available operations will be limited to the following two levels:
 - A2DP profile (Advanced Audio Distribution Profile): You can only playback songs on your audio player.
 - AVRCP profile (Audio/Video Remote Control Profile): You can perform playback, pause playback, select songs, etc.
- Since there are a number of Bluetooth audio players available on the market, available operations will vary extensively. When operating your player with this unit, refer to the instruction manual that came with your Bluetooth audio player as well as this manual.
- As the signal from your cellular phone may cause noise, avoid using it when you are listening to songs on your Bluetooth audio player.

Playing audio

- When a call is in progress on the cellular phone connected to this unit via Bluetooth wireless technology, the sound of the Bluetooth audio player connected to this unit is muted.
- The play time may not display correctly.
- Depending on the type of Bluetooth audio player you have connected to this unit, operation and information display may not be available for some functions.

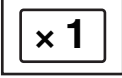
Touch panel keys

1		Switching the text information to display on this unit when playing MP3/WMA/AAC/WAV files.
2		Displaying a list of track titles/file names to select songs on a CD. Refer to <i>Selecting tracks from the track title list</i> on page 47. Displaying the file name list to select the files. Refer to <i>Selecting files from the file name list</i> on page 47. Displaying iPod menus. Refer to <i>Browsing for a video/music on the iPod</i> on page 44.
3		Switching between media file types on a DVD/CD/USB/SD. Refer to <i>Switching the media file type</i> on page 41.
4		Switching the S.Rtrv (sound retriever) function setting when playing audio. Refer to <i>Using sound retriever</i> on page 47.
5		Playing songs in random order. Refer to <i>Random play (shuffle)</i> on page 42.
6		Selecting the repeat range. Refer to <i>Repeating play back</i> on page 42.

7	 	Selecting a folder.
8		Pausing and starting playback.
9		Starting MIXTRAX EZ. Refer to <i>Introduction of MIXTRAX EZ operation</i> on page 33.
10		Conducting operation from your iPod and listening to it using your car's speakers. Refer to <i>Operating this unit's iPod function from your iPod</i> on page 42.
11		Playing songs on the iPod in random order. Refer to <i>Random play (shuffle)</i> on page 42.
12		Changing the speed of audiobook playback on the iPod. Refer to <i>Changing audio book speed</i> on page 47.
13		Performing operations from this unit and listening to the music on your iPod using your car's speakers.
14		Changing the screen mode. Refer to <i>Changing the wide screen mode</i> on page 49.
15		Displaying the MIXTRAX screen. Refer to <i>Introduction of MIXTRAX operation</i> on page 33.
16		Start Music browse mode. Refer to <i>Music Browse mode</i> on page 48.

Playing audio

Text information

17



Displaying the **Songs** list on the iPod.

This function is available for USB/SD when using Music browse mode. Refer to *Searching for a video/music by category* on page 44.

18



Displaying the **Artists** list on the iPod.

This function is available for USB/SD when using Music browse mode. Refer to *Searching for a video/music by category* on page 44.

19



Displaying the **Albums** list on the iPod.

This function is available for USB/SD when using Music browse mode. Refer to *Searching for a video/music by category* on page 44.

20



Displaying the **Genres** list on the iPod.

This function is available for USB/SD when using Music browse mode. Refer to *Searching for a video/music by category* on page 44.

Artwork display

21

Starting **Album Link Search** on your iPod when you touch the artwork display.

This function is available for USB/SD when using Music browse mode.

Refer to *Displaying lists related to the currently playing song (Link Search)* on page 47.

Playing back sound

1 Insert the disc into the disc loading slot with the label side up.

Playback will automatically start.

- While an iPod is connected to this unit, **PIONEER, Accessory Attached** or ✓ (check mark) is displayed on the iPod.
- When the source icon is not displayed, it can be displayed by touching the screen.
- Disconnect headphones from the iPod before connecting it to this unit.
- Depending on the iPod model and the amount of data stored in the iPod, it may take some time for playback to begin.
- Use the touch panel keys to select the iPod after connecting it to this unit.
- **No Device** is displayed when disconnecting the iPod.

Ejecting a disc/SD

- Refer to *Ejecting a disc* on page 17.
- Refer to *Ejecting an SD* on page 18.

Selecting a track using the buttons

1 Press ◀ or ▶ (TRK).

Fast forwarding or reversing using the buttons

1 Press and hold ◀ or ▶ (TRK).

Note

Touch panel keys not listed under *Introduction of sound playback operations* may appear on the display.

Refer to *Indicator list* on page 98.

Setting up for Bluetooth audio

Before you can use the Bluetooth audio function you must establish a Bluetooth wireless connection between the unit and your Bluetooth audio player.

1 Connection

First, you need to connect a Bluetooth audio to this unit.

For detailed instructions on connecting your Bluetooth audio to this unit via Bluetooth wireless technology, see *Introduction of Bluetooth connection menu operations* on page 71.

Notes

- When playing back files recorded as VBR (variable bit rate) files, the play time will not be correctly displayed if fast forward or reverse operations are used.
- To ensure proper operation, connect the dock connector cable from the iPod directly to this unit.
- While the iPod is connected to this unit, the iPod cannot be turned on or off.
- If the characters recorded on the disc are not compatible with this unit, those characters will not be displayed.
- Text information may not be correctly displayed depending on the recorded environment.
- Disconnect the USB portable audio player/USB memory when you are done using it.
- When you select **Speana** on *Selecting the background display* on page 74, the artwork is not displayed.

Advanced App Mode

Introduction of Advanced App Mode operation

This system can switch to the Advanced App Mode, which you can display and operate the application for iPhone on the screen. In Advanced App Mode, you can operate applications with finger gestures such as tapping, dragging, scrolling or flicking on the screen of the system.

- Pioneer is not liable for any issues that may arise from incorrect or flawed app based content.
- The content and functionality of the supported applications are the responsibility of the App providers.
- In Advanced App Mode, functionality through the product is limited while driving, with available functions determined by the App providers.
- Availability of Advanced App Mode functionality is determined by the App provider, and not determined by Pioneer.
- Advanced App Mode allows access to applications other than those listed (subject to limitations while driving), but the extent to which content can be used is determined by the App providers.

Advanced App Mode is compatible with the following iPod models.

- iPhone 4S
- iPhone 4
- iPod touch 4th generation

Applications operable by switching this system to Advanced App Mode are only those available for Advanced App Mode. Please check iPhone applications supported Advanced App Mode at <http://www.pioneerelectronics.com/AppRadio>

Important

- Use the CD IU201S (sold separately) when you use this function.

- The port that supports Advanced App Mode will only be USB input 1.
- When you use this function, set the RGB input to iPhone. For details, refer to *Setting the RGB Input* on page 64.
- Depending on the application, you can input text on the display.
- When using application which allows you to input text on the keyboard, set the language setting of this unit and your iPod. For details, refer to *Setting the Keyboard* on the next page.
- When listening to music and sounds from application simultaneously, see the following section. Refer to *Setting the App sound mixing* on page 64.

CAUTION

- While driving, you cannot enter text on your iPod.
- Use the connected iPod to open an application.

Starting procedure

1 Set RGB Input to iPhone.

When you use this function, set the RGB input to iPhone. For details, refer to *Setting the RGB Input* on page 64.

2 Start an application available for Advanced App Mode from the iPhone.

An image of the application is displayed on the screen of this system.

- You can start an application available for Advanced App Mode also from a launcher application.

3 Touch MODE to hide the AV source icons or wait until the source icons disappear.

- If the source icons are displayed, you cannot conduct the operation of application on the screen.

4 Operate the application.

Setting the Keyboard

CAUTION

For your safety, the keyboard functionality is only available when the vehicle is stopped and the parking brake is engaged.

Depending on the application, you can input text on the display. In order to input text correctly using keyboard which appears on this unit, you need to set the language setting in this function.

When the Advanced App Mode is used, the language setting for the keyboard set for the function and the language setting for the iPhone keyboard need to be the same.

- Keyboard is available only in Advanced App Mode.

When you tap a text input area of an application for iPhone, a keyboard will be displayed on screen. You can input the desired text directly from this system.

- The language preference for the keyboard of this system should be same as the setting on your iPhone.

If the settings for this product and the iPhone are different, you may not be able to enter characters properly.

1 Display the system menu.



Refer to *Introduction of menu operations* on page 56.

2 Touch Keyboard on the System menu to select desired language.

3 Touch the desired language.

French (French) **German** (German) **Greek** (Greek) **Russian** (Russian) **English** (English) **English (UK)** (English) **Dutch** (Dutch)
Italian (Italian) **Norwegian** (Norwegian)
Swedish (Swedish) **Finnish** (Finnish)
Spanish (Spanish) **Portuguese** (Portuguese)

4 Tap the text input area on the application screen of the iPhone.

Touch  to hide the keyboard. 

Using MIXTRAX

Introduction of MIXTRAX operation

You can play the audio files of USB/SD.

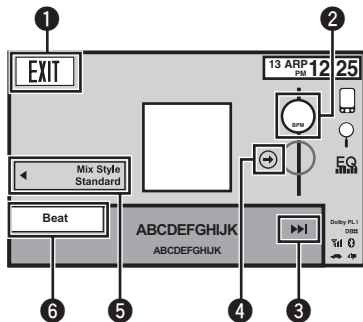

MIXTRAX is original technology for creating non stop mixes of selections from your audio library, complete with DJ effects that make them sound as if a DJ is right there with you playing the music.

Using MIXTRAX

You can enjoy your music files by installing the MIXTRAX software to your computer and using the software to transfer the files to USB devices and SD cards.

The MIXTRAX software can be downloaded from the website below.

<http://www.mixtraxnet.com>

For details on how to use the MIXTRAX software, refer to the online manual.

Important

The artwork display can be moved based on the music type. For details, refer to *Setting the Artwork Dance* on page 67.

Touch panel keys

①		Switching to the audio mode of USB/SD.
②		Changing the BPM (Beats Per Minute).

③		Starting playback of the next song.
④		Switching to the original BPM (Beats Per Minute). The original BPM (Beats Per Minute) does not display during playback.
⑤		Switching to the Mixstyle display. You can select the desired Mixstyle in the display.
⑥		Switching to the Mix playlist. You can select the desired Mix playlist.

Starting playback of the next song.	
①	Press ▶ (TRK).

Introduction of MIXTRAX EZ operation

You can play the audio files of iPod/USB/SD. MIXTRAX EZ is used to add a variety of sound effects between songs for arranging the pauses between songs. It allows you to enjoy listening to music nonstop.

- This function is only available when a file on an external storage device (USB, SD) or a song on an iPod is being played.
- This function is not available when the control mode is set to **App Mode**.
- Depending on the file/song, sound effects may not be enabled for adding.
- Depending on the file/song, non stop playback may not be available.

Pandora operations

To play Pandora on the Pioneer car audio/video products, connect an iPod or iPhone with the most recent Pandora application installed, and start the Pandora application.

Important

Requirements to access Pandora using the Pioneer car audio/video products: Connect your iPod to USB input 1 when you play Pandora.

- iPod and iPhone compatibility
Apple iPhone (first generation), iPhone 3G, iPhone 3GS, iPhone 4, iPod touch 1G, iPod touch 2G, iPod touch 3G or iPod touch 4G (firmware version 3.0 or later).
Certain firmware versions for the iPod touch and iPhone may not be compatible with the Pandora application. If this appears to be the case, please update the firmware to a version that is compatible with Pandora.
- Latest version of the Pandora application, downloaded to your device. (Search Apple iTunes App Store for "Pandora").
- Current Pandora account (Free account and paid accounts available from Pandora; create a free account online at <http://www.pandora.com/register> or through the Pandora application for the iPhone).
- Data Plan.

Note: If the Data Plan for your iPhone does not provide for unlimited data usage, *additional charges from your carrier may apply* for accessing the Pandora service via 3G and/or EDGE networks.

- Connection to the Internet via 3G, EDGE or Wi Fi network.
- Optional Pioneer adapter cable connecting your iPhone to the Pioneer car audio/video products.

Limitations:



- Access to the Pandora service will depend on the availability of a cellular and/or Wi Fi network for purposes of allowing your device to connect to the Internet.

- Ability of the Pioneer car audio/video products to access the Pandora service is subject to change without notice and could be affected by any of the following: compatibility issues with future firmware versions of iPhones; compatibility issues with future firmware versions of the Pandora application for the iPhone; changes to the Pandora music service by Pandora; discontinuation of the Pandora music service by Pandora.
- Certain functions of the Pandora service are not available when accessing the service through the Pioneer car audio/video products, including, but not limited to, creating new stations, deleting stations, emailing current stations, buying tracks from iTunes, viewing additional text information, logging in to Pandora, and adjusting Cell Network Audio Quality.

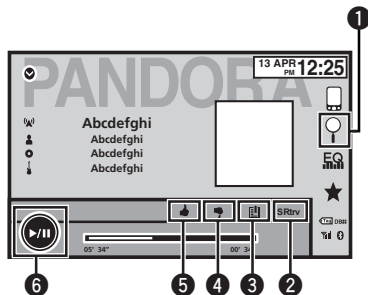
Pandora internet radio is a music service not affiliated with Pioneer. More information is available at <http://www.pandora.com>.



Touch panel keys

- | | | |
|---|---|---|
| ❶ |  | Displaying the QuickMix/station list to select QuickMix or the desired station.
Refer to <i>Selecting and playing Pandora® stations/QuickMix</i> on page 43. |
| ❷ |  | Switching the S.Rtrv (sound retriever) function setting while playing Pandora.
Refer to <i>Using sound retriever</i> on page 47. |

Using Pandora® internet radio

3		Storing track information (Bookmark).
4		Giving a "Thumbs down" for the track currently playing and then skipping to the next track.
5		Giving a "Thumbs up" for the track currently playing.
6		Pausing and starting playback.

Playing tracks

- 1 Connect an iPod to USB input 1 with a USB cable using an iPod or iPhone Dock Connector.
- 2 Start up the Pandora application installed on the iPod or iPhone.

Skipping tracks

- 1 Press ► (TRK).

Notes

- Touch panel keys not listed under *Pandora operations* may appear on the display. Refer to *Indicator list* on page 98.
- Pandora limits the number of skips allowed on their service. If you attempt to skip songs beyond the limit, "SKIP LIMIT REACHED" is displayed. If you have reached the skip limit and you give a "thumbs down", the current track will continue to play, but your feedback will be registered. ■

Introduction of still image playback operations

You can view still images saved in USB/SD.

Still image

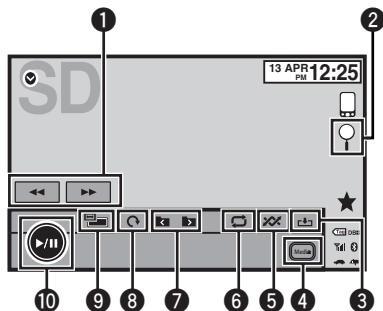

When loading a USB/SD containing JPEG picture files, this unit starts a slideshow from the first folder/picture on the device.

The table below shows the controls for viewing a slideshow.

Touch panel keys

1		Selecting a picture.
2		Displaying the file name list to select the files. Refer to <i>Selecting files from the file name list</i> on page 47.
3		Capturing an image in JPEG files. Refer to <i>Capture an image in JPEG files</i> on page 49.

4		Switching between media file types when there is more than one media file type saved to the USB or SD device. This key does not appear if there is only one media file type saved to the USB or SD device. Refer to <i>Switching the media file type</i> on page 41.
---	--	--

5		Playing files in a random order. Refer to <i>Random play (shuffle)</i> on page 42.
---	--	--

6		Selecting the repeat range. Refer to <i>Repeating play back</i> on page 42.
---	--	---

7		Selecting a folder.

8		Rotating the displayed picture 90° clockwise.
---	--	---

9		Changing the screen mode. Refer to <i>Changing the wide screen mode</i> on page 49.
---	--	---

10		Starting or pausing the slideshow.
----	--	------------------------------------

Playing still images

- 1 Connect the USB/SD device. Playback will automatically start.
 - When the source icon is not displayed, it can be displayed by touching the screen.

Ejecting an SD

- Refer to *Ejecting an SD* on page 18.

Playing still images

Selecting a file using the buttons

1 Press ◀ or ▶ (TRK).

Fast file searching

1 Press and hold ◀ or ▶ (TRK).

- You can search 10 JPEG files at a time.

Notes

- Files are played back in file number order and folders are skipped if they contain no files. (If folder **1** (ROOT) contains no files, playback commences with folder **2**.)
- Touch panel keys not listed under *Introduction of still image playback operations* may appear on the display.
Refer to *Indicator list* on page 98. ◻

Introduction of Bluetooth telephone operations

You can use Bluetooth telephone.

Telephone standby display

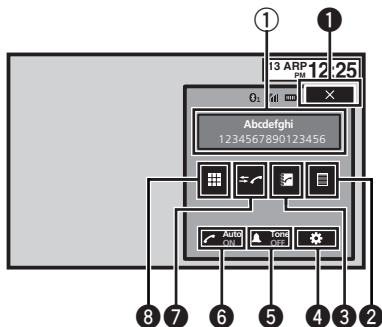

When switching to the entering phone number mode

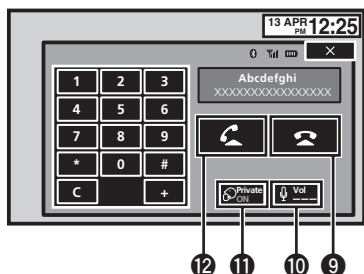

Important

- Since this unit is on standby to connect with your cellular phone via Bluetooth wireless technology, using it without the engine running can drain the battery power.
- Advanced operations that require attention such as dialing numbers on the monitor, etc., are prohibited while driving. Park your vehicle in a safe place when using these advanced operations.
- Bluetooth connection menu cannot be selected while driving.
- Operations available may be limited depending on the cellular phone connected to this unit.

- Be sure to park your vehicle in a safe place and apply the parking brake when performing this operation.
- If you are unable to complete the connection using this unit, use the device to connect to the unit.
- If you connect more than one device at a time, connected device may not operate properly. Connecting one device at a time is recommended.

① Incoming call notice

Indicates that an incoming call has been received and has not been checked yet.

- Not displayed for calls made when your cellular phone is disconnected from this unit.

Touch panel keys

①		Display is closed.
②		Displaying the preset dial screen. Refer to <i>Using the preset dial lists</i> on page 54.
③		Switching to the phone book mode. Refer to <i>Calling a number in the phone book</i> on page 52. Refer to <i>Selecting a number by alphabet search mode</i> on page 53.
④		Displaying the Bluetooth connection menu. Refer to the instructions from page 71 to page 73.
⑤		Turning the ring tone for incoming calls on or off. Refer to <i>Switching the ring tone</i> on page 54.
⑥		Turning automatic answering on or off. Refer to <i>Setting automatic answering</i> on page 54.

Bluetooth telephone

7		Switching to the call history list. Refer to <i>Using the missed, received and dialed call lists</i> on page 53.
8		Switching the mode to enter the phone number directly. Refer to <i>Making a call by entering phone number</i> on page 55.
9		Ending a call. Rejecting an incoming call. Canceling call waiting.
10		Adjusting the other party's listening volume. Refer to <i>Adjusting the other party's listening volume</i> on page 54.
11		Turning private mode on or off. Refer to <i>Setting the private mode</i> on page 55.
12		Accepting an incoming call. Making a phone call, when selecting a phone number. Switching between callers on hold.

- 1 Connection

First, you need to connect a Bluetooth telephone to this unit.

For detailed instructions on connecting your phone to this unit via Bluetooth wireless technology, see following section. *Using a Bluetooth device to pair* on page 72 and *Pairing from this unit* on page 71.
- 2 Volume adjustment

Adjust the earpiece volume of your cellular phone to your preference. The unit will record the adjusted volume level as the default setting.

 - The volume of the caller's voice and ring tone may vary depending on the type of cellular phone.
 - If there is a large volume difference between the ring tone and caller's voice, the overall volume level may become unstable.
 - Make sure to adjust the volume to a proper level before disconnecting the cellular phone from the unit. If the volume is muted (zero level) on your cellular phone, the volume level of your cellular phone remains muted even after the cellular phone is disconnected.

Notes

- Private mode can only be operated while you are talking on the phone.
- To end the call, both you and the other caller must hang up your phones.
- Touch panel keys not listed under *Introduction of Bluetooth telephone operations* may appear on the display.
Refer to *Indicator list* on page 98.

Setting up for hands-free phoning

Before you can use the hands free phoning function you must set up the unit for use with your cellular phone. This entails establishing a Bluetooth wireless connection between this unit and your phone, registering your phone with this unit, and adjusting the volume level.

Storing and recalling stations

You can easily store up to six stations for each band as presets.

- Six stations for each band can be stored in memory.
- Channels are stored and recalled on a broadcast station basis. This means that if the broadcast station you stored has been assigned to a different channel by SIRIUS, you can still recall the same broadcast station (though a different channel number may appear in the display).

1 Display the preset channel list screen.

Refer to *Introduction of XM/SIRIUS tuner operations* on page 22.

Refer to *Introduction of HD Radio tuner operations* on page 20.

The preset channel list appears in the display.

2 Touch and hold one of the preset tuning keys to store the selected frequency in the memory.

The selected radio station frequency has been stored in the memory.

3 Touch one of the preset tuning keys to select the desired station.

Storing the strongest stations

BSM (best stations memory) automatically stores the six strongest stations in the order of their signal strength.

Storing broadcast frequencies with BSM may replace broadcast frequencies you have saved using the preset tuning keys.

1 Display the preset channel list screen.

Refer to *Introduction of HD Radio tuner operations* on page 20.

The preset channel list appears in the display.

2 Touch BSM to turn BSM on.

The six strongest broadcast frequencies will be stored under preset tuning keys in order of their signal strength.

- To cancel the storage process, touch

Cancel. 

Tuning in to strong signals

Local seek tuning lets you tune in to only those radio stations with sufficiently strong signals for good reception.

FM: Off 



AM: Off 

The highest level setting allows reception of only the strongest stations, while lower levels allow the reception of weaker stations. 

Using iTunes tagging

This function can be operated with the following iPod models.

iPod touch 4th generation
iPod touch 3rd generation
iPod touch 2nd generation
iPod touch 1st generation
iPod classic 160GB
iPod classic 120GB
iPod classic
iPod with video
iPod nano 6th generation
iPod nano 5th generation
iPod nano 4th generation
iPod nano 3rd generation
iPhone 4S
iPhone 4
iPhone 3GS
iPhone 3G
iPhone

The song information (tag) can be saved from the broadcasting station to your iPod. The songs will show up in a playlist called “Tagged playlist” in iTunes the next time you sync your iPod. Then you can directly buy the songs you want from the iTunes Store.

The tagged songs and the song that you can buy from the iTunes Store may be different. Make sure to confirm the song before you make the purchase.

If you cannot use this function normally, update your iPod firmware.

Detailed instructions

Storing the tag information to this unit

1 Tune in to the broadcast station.

2 Store the tag information to this unit.

Refer to *Introduction of HD Radio tuner operations* on page 20.

You can store the information if the **Tag** indicator is displayed while the desired song is being broadcast.

- While storing the tag data on this unit, **Tag** flashes.
- The tag information for up to 50 songs can be stored on this unit.
- Depending on the timing of when the tag information is stored, the tag information for the song played before or after the currently playing song may also be stored.
- If an SD is selected as the source while tag information is being stored to this unit, the tag information will not be transferred to the iPod.

3 When completed, indicator turns off and indicator is displayed.

Storing the tagged information to your iPod

1 Connect your iPod.

When your iPod is connected to this unit, your iPod starts storing the tagged information automatically.

- While transferring the tag, you cannot select the SD source.

2 When completed, indicator turns off and the tagged information is stored on your iPod. .

Switching the media file type

When playing a digital media containing a mixture of various media file types, such as DivX, MPEG 1, MPEG 2, MPEG 4 and MP3, you can switch between media file types to play.

Audio data (CD DA) and JPEG picture files on DVD R/RW/ROM cannot be played back on this unit.

CD (audio data (CD DA)) **Music/ROM** (compressed audio) **Video** (DivX, MPEG 1, MPEG 2, MPEG 4 video files) **Photo** (JPEG picture files) 

Operating the DVD menu

(Function for DVD video)

Some DVDs allow you to make a selection from the disc contents using a menu.

Using the arrow keys

1 Display arrow keys to operate the DVD menu.

Refer to *Playing moving images* on page 24.

2 Select the desired menu item.



Selecting the desired menu item.

Enter

Starting playback from the selected menu item.

Touch

Operating the DVD menu by directly touching the menu item.



Back to Previous display.

- When operating the DVD menu by directly touching the menu item, touch the icon to operate.

Key

Returning to the normal DVD video display.



Displaying arrow keys.

- Ways to display the menu will differ depending on the disc.
- Depending on the contents of the DVD disc, this function may not work properly. In such cases, use the touch panel keys to operate the DVD menu.

Operating this unit's iPod function from your iPod

You can listen to the sound from your iPod applications using your car's speakers, when **App Mode** is selected.

This function is not compatible with the following iPod models.

- iPod nano 1st generation
- iPod with video
- While this function is in use, the iPod will not turn off even if the ignition key is turned off. Operate the iPod to turn off the power.

1 Switch the control mode to App Mode.

Refer to *Introduction of video playback operations* on page 24.

Refer to *Introduction of sound playback operations* on page 27.

2 Operate the connected iPod to select a video/song and play.

Notes

- The following functions are still accessible from the unit even if the control mode is set to **App Mode**. However, the operation will depend on your applications.
 - Playing/pausing
 - Fast forwarding/reversing
 - Tracking up/down
 - Moving to a chapter up/down

- **App Mode** is compatible with the following iPod models.
 - iPod touch 4th generation
 - iPod touch 3rd generation
 - iPod touch 2nd generation
 - iPod touch 1st generation
 - iPod classic 160GB
 - iPod classic 120GB
 - iPod classic
 - iPod nano 6th generation
 - iPod nano 5th generation
 - iPod nano 4th generation
 - iPod nano 3rd generation
 - iPod nano 2nd generation
 - iPhone 4S
 - iPhone 4
 - iPhone 3GS
 - iPhone 3G
 - iPhone

Random play (shuffle)

iPod videos/songs can be played back in random order.

- **Songs** Play back videos/songs in the selected list in random order.
- **Albums** Play back videos/songs from a randomly selected album in order.
- **Folder** Play back songs/tracks in the selected folder in random order.
- **Disc** Play back songs/tracks in the selected disc in random order.
- **On** Play back files in random order within the repeat range, **Folder** and **Disc**.
- **Off** Cancel random play.

Repeating playback

- **Disc** Play through the current disc
- **Chapter** Repeat the current chapter
- **Title** Repeat the current title
- **Track** Repeat the current track
- **File** Repeat the current file
- **Folder** Repeat the current folder
- **One** Repeat just the current video/song
- **All** Repeat all videos/songs in the selected list on the iPod

Detailed instructions

- This function cannot be operated during Video CD playback featuring PBC (playback control).
- If you perform chapter search, fast forward/reverse, frame by frame playback or slow motion playback, the repeat play will stop.
- When playing discs with compressed audio and audio data (CD DA), playback is repeated within the type of data currently playing even if **Disc** is selected.
- If you select another folder during repeat play, the repeat play range changes to **Disc**. If you select USB or SD source, the repeat play range changes to **All**.
- If you perform track search or fast forward/reverse during **File**, the repeat play range changes to **Folder**.
- If you perform title/chapter search or fast forward/reverse during **Chapter**, the repeat play is set to off automatically.
- If you perform track search or fast forward/reverse during **Track**, the repeat play range changes to **Disc**.
- When **Folder** is selected, it is not possible to play back a subfolder of that folder.

Playing videos from your iPod

(Function for iPod)

Videos can be played on this unit if an iPod with video capabilities is connected.

- This unit can play back "Movies", "Music videos", "Video Podcast" and "TV show" which are downloaded from the iTunes store.

1 Display the iPod menus.

Refer to *Playing moving images* on page 24.

2 Switch to iPod video mode.

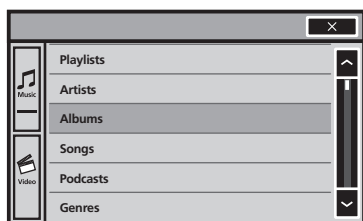

- If you want to switch to iPod video mode, touch the icon.



Switching to iPod video mode.

3 Play the video from the iPod.

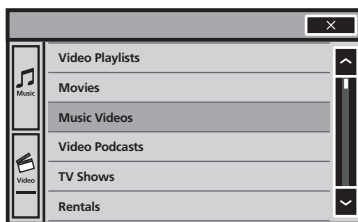

- If you want to switch to iPod music mode, touch the icon.



Switching to iPod music mode.



Playing videos from USB storage device and SD

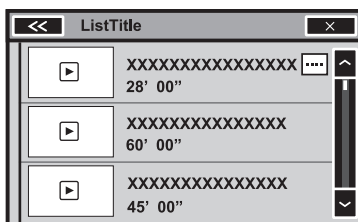

Touch the playback sign of the thumbnail to preview the file. Touch the title to start playback.

Selecting and playing Pandora® stations/QuickMix

Touch the list for your Pandora stations to select one of them to play.

Detailed instructions

1 Display the QuickMix/station list.

Refer to *Pandora operations* on page 34.

2 Change the sort order.



You can sort the items in the list alphabetically.



You can sort the items in the list in order of the dates on which the items were created.



You can scroll the titles in the list while you touch and hold down the scroll icon.

3 Select QuickMix or the desired station.



You can play only one song at a time from a shuffled mix of several stations.



- **Artists** (artists)
- **Albums** (albums)
- **Songs** (songs)
- **Podcasts** (podcasts)
- **Genres** (genres)
- **Composers** (composers)
- **Audiobooks** (audiobooks)

3 Touch the title of the list that you want to play.

Repeat this operation until you find the desired video/music.

Notes

- You can play playlists created with the PC application (MusicSphere). The application will be available on our website.
- Playlists that you created with the PC application (MusicSphere) are displayed in abbreviated form.

Browsing for a video/music on the iPod

(Function for iPod)

To make operating and searching easy, operations to control an iPod with this unit are designed to be as similar to the iPod as possible.

Searching for a video/music by category

1 Display the iPod menus.

Refer to *Playing moving images* on page 24.

Refer to *Playing audio* on page 27.

2 Touch one of the categories in which you want to search for a video/music.

- **Video Playlists** (video playlists)
- **Movies** (movies)
- **Music Videos** (music videos)
- **Video Podcasts** (video podcasts)
- **TV Shows** (TV shows)
- **Rentals** (rentals)
- **Playlists** (playlists)

Detailed instructions

Searching the list by alphabet

(Function for iPod)

1 Select a category.

Refer to *Searching for a video/music by category* on the previous page.

2 Switch to alphabet search mode.



Switching to alphabet search mode.

Alphabet search mode is displayed.

3 Touch the first letter of the title of the video/song you are looking for.

While searching, touch panel key operation is not available.

- To refine the search with a different letter, touch **Cancel**.

4 Touch the title of the list that you want to play.

Repeat this operation until you find the desired song/video.

Resume playback (Bookmark)

(Function for DVD video)

By using the Bookmark function, you can resume playback from a selected scene the next time the disc is loaded.

The selected scene will be bookmarked so that playback resumes from that point next time.

- To clear the bookmark on a disc, touch and hold the key during playback.
- The oldest bookmark is replaced by the new one.

Frame-by-frame playback

(Function for DVD video/video CD/DivX file/MPEG 1/MPEG 2/MPEG 4)

Note

Images during frame by frame playback may be unclear for some discs.

Slow motion playback

Notes

- There is no sound during slow motion playback.
- Images during slow motion playback may be unclear for some discs.
- Reverse slow motion playback is not available.

Searching for the part you want to play

You can use the search function to find the part you want to play.

For DVD videos, you can select **Title** (title), **Chapter** (chapter) or **10key** (numeric keypad). For video CDs, you can select **Track** (track) or **10key** (numeric keypad).

- Chapter search is not available when disc playback is stopped.
- This function cannot be operated during some DVD videos or Video CD playback featuring PBC (playback control).

1 Start the search function.

Refer to *Playing moving images* on page 24.

2 Touch the desired search option (e.g., Chapter).

3 Touch 0 to 9 to input the desired number.

- To cancel the entered numbers, touch **C**.

4 Start playback from the selected part.



Registering the numbers and starting playback.

Note

With discs featuring a menu, you can also use the DVD menu to make your selection.

Refer to *Playing moving images* on page 24.

Changing audio language during playback (Multi-audio)

With DVDs/DivX files that provides audio playback in different languages and different audio systems (Dolby Digital, DTS, etc.), you can switch between languages/audio systems during playback.

Notes

- With some DVDs, switching between languages/audio systems may only be possible using a menu display.
- You can also switch between languages/audio systems using **Video Setup** menu. For details, refer to *Setting the audio language* on page 60.
- Depending on the setting, the video may not be played back with the audio system used to record the DVD.
- You will return to normal playback if you change the **Audio** during fast forward/fast reverse, pause or slow motion playback. 

Changing the subtitle language during playback (Multi-subtitle)

With DVDs/DivX files featuring multi subtitle recordings, you can switch between subtitle languages during playback.

Notes

- With some DVDs, switching between subtitle languages may only be possible using a menu display.
- You can also switch between subtitle languages using **Video Setup** menu. For details, refer to *Setting the subtitle language* on page 60.
- You will return to normal playback if you change the **Subtitle** during fast forward/fast reverse, pause or slow motion playback. 

Changing the viewing angle during playback (Multi-angle)

With DVDs featuring multi angle (scenes shot from multiple angles) recordings, you can switch among viewing angles during playback.

- During playback of a scene shot from multiple angles, the angle icon is displayed. Use the **Video Setup** menu to turn the angle icon display on or off. For details, refer to *Setting the multi angle DVD display* on page 60.

Note

You will return to normal playback if you change the viewing angle during fast forward/fast reverse, pause or slow motion playback. 

Return to the specified scene

(Function for DVD video)

This function cannot be used if a specified scene has not been preprogrammed on the DVD disc. 

Selecting audio output

When playing DVD video discs recorded with LPCM audio, you can switch the audio output. When playing video CDs, you can switch between stereo and monaural audio output.

- This function is not available when disc playback is stopped.
- **L+R** Left and right
- **Left** Left
- **Right** Right
- **Mix** Mixing left and right

Note

You may not be able to select or use this function depending on the disc and the playback location. 

Detailed instructions

PBC playback

(Function for Video CDs)

During playback of Video CDs featuring PBC (playback control), **PBC On** is displayed.

1 Start the search function.

Refer to *Playing moving images* on page 24.

2 Touch 10key to display the numeric keypad.

3 Touch 0 to 9 corresponding to a menu number.

4 Start playback from the selected part.



Registering the numbers and starting playback.

Notes

- You can display the menu by touching **Return** during PBC playback. For details, refer to the instructions provided with the disc.
- PBC playback of a Video CD cannot be canceled.
- During playback of Video CDs featuring PBC (playback control), you cannot select the repeat play range or use the search function.

Selecting tracks from the track title list

You can select tracks to playback using the track title list which is a list of the tracks recorded on a disc.

1 Display the track title list.

Refer to *Playing audio* on page 27.

2 Touch your favorite track title.

Playback begins.

Selecting files from the file name list

(Function for compressed audio/DivX/MPEG 1/MPEG 2/MPEG 4)

File name list is a list of file names (or folder names) from which you can select a file (or folder) to playback.

1 Display the file (or folder) name list.

Refer to *Playing audio* on page 27.

Refer to *Introduction of still image playback operations* on page 36.

2 Touch your favorite file (or folder) name.

- When you have selected a folder, a list of the names of the files (or the folders) in it can be viewed. Repeat this operation to select the desired file name.
- If folder **1** (ROOT) contains no files, playback commences with folder **2**.

Note

If part of the recorded information does not display, a scroll key appears on the right side of list. Touch the scroll key to scroll.

Using sound retriever

Automatically enhances compressed audio and restores rich sound.

Off

- is more effective than .

Changing audiobook speed

(Function for iPod)

- Playback at a speed faster than normal
- Playback at normal speed
- Playback at a speed slower than normal

Displaying lists related to the currently playing song (Link Search)

(Function for iPod/USB/SD)

1 Touch the artwork display.

Refer to *Introduction of sound playback operations* on page 27.

2 Touch the title of the list that you want to play.

Notes

- If part of the recorded information does not display, a scroll key appears on the right side of list. Touch the scroll key to scroll.
- This function is available for USB/SD when using Music browse mode. 

Setting the Advanced Display Resolution

(Function for USB/SD)

You can increase the resolution of moving images on your USB/SD storage device.

OFF 1 2

- With some pictures, display adjustment may not be possible.
- There may not be any effect observed in some cases depending on the images being played back. 

Music Browse mode

(Function for USB/SD)

This unit creates an index in order to facilitate browsing for a song. You can search by the categories such as Albums and Artists.

CAUTION

- This function is not available when the USB/SD storage device is locked.
- This function is not available when the free space of USB/SD storage device is 5MB.
- While this unit creates an index, do not turn the unit off. It may cause loss of data on your USB/SD storage device.

1 Create the database in Music browse mode.

Refer to *Introduction of sound playback operations* on page 27.

2 When “Save the Database to memory?” is displayed, touch “Yes”

Saving of the database is completed. If you do not save it, touch “No”.

When the saving is completed, “**Database save to memory was completed.**” appears.

3 Display a list and touch the tag key.

4 Select a file.

Music browse mode will start. 

Playing DivX® VOD content

Some DivX video on demand (VOD) content may only be playable a fixed number of times. When you load a disc containing this type of content, the number of times it has been played will be shown on screen. You can then decide whether or not to play the disc.

- If there is no limit to the number of times the DivX VOD content can be viewed, then you may load the disc into your player and play the content as often as you like, and no message will be displayed.
- You can confirm the number of times that the content can be played by checking the number displayed after **This DivX rental has used** **out of** **views..**

Important

- In order to play DivX VOD contents on this unit, you first need to register the unit with your DivX VOD contents provider. For details on your registration code, refer to *Displaying the DivX® VOD registration code* on page 63.
- DivX VOD content is protected by a DRM (Digital Rights Management) system. This restricts playback of content to specific, registered devices.
- **If a message is displayed after loading a disc containing DivX VOD content, touch Play.**
Playback of the DivX VOD content will start.
 - To skip to the next file, touch **Next Play**.
 - If you do not want to play the DivX VOD content, touch **Stop**. 

Detailed instructions

Capture an image in JPEG files

You can capture image data and use it as wall paper. Images can be stored and recalled easily in this unit.

- Only one image can be stored on this unit. Old image is overwritten with the new one.

1 Pause the slideshow when the desired image is displayed.

Refer to *Introduction of still image playback operations* on page 36.

2 Capture the image.

Refer to *Introduction of still image playback operations* on page 36.

3 When "Do you save this image?" is displayed, touch Yes.

While storing the image to this unit, "Saving the image. Don't switch off the battery." is displayed. When the process is finished, "Image saved." is displayed.

- To cancel the storage process, touch **No**. 

Changing the wide screen mode

You can select a desired mode for enlarging a 4:3 picture to a 16:9 picture.

1 Display the screen mode.

Refer to *Introduction of video playback operations* on page 24.

Refer to *Introduction of still image playback operations* on page 36.

2 Touch the desired wide mode setting.

FULL (full screen)

The 4:3 picture is enlarged in the horizontal direction only, giving you a 4:3 TV picture (normal picture) without any omissions.

ZOOM (zoom)

The 4:3 picture is enlarged in the same proportion both vertically and horizontally; ideal for a cinema sized picture (wide screen picture).

NORMAL (normal)

The 4:3 picture is displayed as it is, giving you no sense of disparity since its proportions are the same as that of the normal picture.

TRIMMING (trimming)

The image is displayed across the entire screen with the horizontal to vertical ratio left as is. If the horizontal to vertical ratio differs between the display and the image, the image may be displayed partly cut off either at the top/bottom or sides.

Notes

- You cannot operate this function while driving.
- Different settings can be stored for each video source.
- When a video is viewed in a wide screen mode that does not match its original aspect ratio, it may appear different.
- Remember that using the wide mode feature of this system for commercial or public viewing purposes may constitute an infringement on the author's rights protected by the Copyright Law.
- The video image will appear coarser when viewed in **ZOOM** mode.
- **FULL/ZOOM/NORMAL** is used for videos. **NORMAL/TRIMMING** is used for JPEG images. 

Switching the XM/SIRIUS channel selection mode

You have two methods for selecting a channel: by number and by category. When selecting by number, channels in any category can be selected. Select by category to narrow your search down to only channels in a particular category.

Mode All CH (channel number select setting)

Mode Category (channel category select setting)

Selecting a SIRIUS channel from a channel category

Channels are organized into various program categories, e.g. Rock, Classic, Jazz while listening to a SIRIUS station. You can specify channels by selecting the desired category.

1 Select channel category selection mode.

Refer to *Introduction of XM/SIRIUS tuner operations* on page 22.

Mode All CH (channel number select setting)

Mode Category (channel category select setting)

2 Touch ◀ or ▶ to select the desired channel category.

3 Touch ◀ or ▶ on the buttons to select the desired channel in the selected channel category.

Selecting a channel from the XM channel list display

The list content can be switched so you can search for the track you want to listen to not only by the channel name but also by the artist name or song title.

- This function is available for GEX P920XM.
- The channel list shows all the channels during **Mode All CH** mode, and the channels included in the selected category during **Mode Category** mode.

1 Display the preset channel list.

Refer to *Introduction of XM/SIRIUS tuner operations* on page 22.

2 Switch the channel list mode.



Switching the channel list mode to the channel name or the artist name/song title.

3 Touch the desired channel that you want to listen to. ◻

Selecting an XM/SIRIUS channel directly

You can select an XM/SIRIUS channel directly by entering the desired channel number.

1 Display the preset channel list.

Refer to *Introduction of XM/SIRIUS tuner operations* on page 22.

2 Switch to direct input display.



Switching to direct input display.

3 Touch 0 to 9 to input the desired channel number.

- To cancel the input numbers, touch **C**.

4 Select the XM/SIRIUS channel of the entered number.

The XM/SIRIUS channel of the entered number is selected.



Selecting the XM/SIRIUS channel of the entered number.

Using the Game Alert function

This system can alert you when games involving your favorite teams are about to start. To use this function you need to set up a game alert for the teams in advance.

- This function is available for SIR PNR2/SIR PNR2C.

Selecting teams for Game Alert

1 Start Game Alert setup.

Refer to *Introduction of XM/SIRIUS tuner operations* on page 22.

Detailed instructions

2 Select a desired league in League.

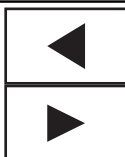

Switching the league name.

3 Select a desired team in Team.

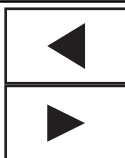

Switching the team name.

4 Turn the alert on or off.



Turning the alert on or off.

The game alert function is activated for that team.

- When you have already selected 12 teams, **FULL** is displayed and additional teams cannot be selected. In this case, first delete a selected team and then try again.

5 Repeat these steps to select other teams.

Up to 12 teams can be selected.

Switching the Game Alert on or off

Once you select the teams, you need to turn the Game Alert function on.

The Game Alert function is on at the default setting.

When a game of a selected team starts

When a game of the selected team is about to start (or is currently playing) on a different station, a game alert is displayed.

Jump

Switching to the other station to listen to the game.

Stay

Not tuning in to the other station.

Displaying game information

If any games of the selected teams are currently playing, you can display information on the games and tune in to the broadcast channel.

1 Display the game information for the selected team.

Refer to *Introduction of XM/SIRIUS tuner operations* on page 22.

2 Touch ◀ or ▶ to select a game.

The game is displayed, followed by more detailed game information.

- The game score will be updated automatically.

3 Switch to the other station to listen to the game.

Tune to

Switching to the other station to listen to the game.

- If you have not selected any teams, **NOT SET** is displayed.
- When games involving your favorite teams are not currently playing, **NO GAME** is displayed.

Displaying the Radio ID

Channel number selection setting

If you select **CH000**, the ID code is displayed.

● Select CH000.

Refer to *Introduction of XM/SIRIUS tuner operations* on page 22.

Switching the SIRIUS display

- Actions will differ depending on the connected SIRIUS tuner.
- **Touch SIRIUS tuner information to switch the SIRIUS display.**
Refer to *Introduction of XM/SIRIUS tuner operations* on page 22.
Channel number Channel name Category name Artist name Song title/Title name Composer name Play time

Note

Play time is displayed during the Instant Replay mode. 

Using the Instant Replay function

The following functions can be operated in Instant Replay mode.

- To use this function, a Pioneer SIRIUS bus interface (e.g. CD SB10) is required.
- To use this function, a SIRIUS plug and play unit with an Instant Replay Function is required.
- For details, refer to the SIRIUS plug and play unit's manuals.

- **To exit from Instant Replay mode, select another source or touch the following icon.**



Exiting from Instant Replay mode.

- **Select a track**

Press ◀ or ▶ (TRK).

- **Fast forward or reverse**

Press and hold ◀ or ▶ (TRK).

- **Pause and play**



Playing and pausing.



Switching the seek mode

There are two seek tuning settings, one is **HD** (Digital broadcasting stations seek) and the other is **ALL** (normal seek).

ALL **HD** 

Switching the reception mode

If the reception for a digital broadcast becomes poor, this unit automatically switches to the analog broadcast of the same frequency. If this function is set to **D/A AUTO**, the tuner switches between digital broadcast and analog broadcast automatically. If this function is set to **ANALOG**, the tuner will only receive analog broadcasts.

D/A AUTO **ANALOG** 

Calling a number in the phone book

The phone book in your cellular phone will be transferred automatically when the phone is connected to this unit.

After finding the number you want to call in the phone book, you can select the entry and make the call.

- 1 Switch to phone book mode.**

Refer to *Introduction of Bluetooth telephone operations* on page 38.

The phone book display appears.

- 2 Select the phone number list.**

The detailed phone number list of the selected entry is displayed.

- 3 Select the phone number.**

- If you want to store the phone number, touch and hold the list.

- 4 Make the call.**

Refer to *Introduction of Bluetooth telephone operations* on page 38.

- 5 End the call.**

Refer to *Introduction of Bluetooth telephone operations* on page 38.

Detailed instructions

Note

Depending on the cellular phone, the phone book may not be transferred automatically. In this case, operate your cellular phone to transfer the phone book. The visibility of this unit should be on. Refer to *Switching visible unit* on page 72. 

Selecting a number by alphabet search mode

If a lot of numbers are registered in the phone book, you can search for the phone number by alphabet search mode.

1 Switch to phone book mode.

Refer to *Introduction of Bluetooth telephone operations* on page 38.

The phone book display appears.

2 Touch ABC to switch to alphabet search mode.

3 Touch the first letter of the entry you are looking for.

The Phone Book entries starting with that letter (e.g. "Ben", "Brian" and "Burt" when "B" is selected) will be displayed.

- If you want to change the character to Russian, touch the icon. To return to English, touch the icon again.



Changing the character to Russian.

- The order of the first name and last name may be different from that of the cellular phone.

4 Touch the list to display the phone number list of the selected entry.

- If several phone numbers are included in an entry, select one by touching the list.
- If you want to switch to the call history list, touch the icon.



Switching to the call history list.

5 Make the call.

Refer to *Introduction of Bluetooth telephone operations* on page 38.

6 End the call.

Refer to *Introduction of Bluetooth telephone operations* on page 38. 

Inverting names in phone book

When your cellular phone is connected to this unit, the first and last names of your contacts may be registered to the phone book in reverse order. You can use this function to change the order back.

(Inverting the names in the phone book)

1 Switch to phone book mode.

Refer to *Introduction of Bluetooth telephone operations* on page 38.

The phone book display appears.

2 Invert names in phone books.



Inverting names in phone books.

3 "Would you like to invert all names?" appears. Touch Yes to continue.

While the names are inverted,  is displayed.

- If the inversion fails, "Invert Name Error" appears. In such cases, try again from the beginning.

Note

Inverting the names of your contacts from this unit does not affect the data on your Bluetooth device. 

Using the missed, received and dialed call lists

The 80 most recent calls dialed, received, and missed are stored in the memory. You can browse them and call numbers from these lists.

Detailed instructions

1 Switch to the call history list.

Refer to *Introduction of Bluetooth telephone operations* on page 38.

2 Select Missed Calls, Dialed Calls or Received Calls.



Displaying the received call list.



Displaying the dialed call list.



Displaying the missed call list.

3 Touch the list number to select a phone number.

Name and phone number are displayed in the detailed list.

- If you want to store the phone number, touch and hold the list.

4 Make the call.

Refer to *Introduction of Bluetooth telephone operations* on page 38.

5 End the call.

Refer to *Introduction of Bluetooth telephone operations* on page 38.

Setting automatic answering

If this function is on, this unit automatically answers all incoming calls.

● Turn automatic answering on or off.

Refer to *Introduction of Bluetooth telephone operations* on page 38.

Adjusting the other party's listening volume

To maintain the good sound quality, this unit can adjust the other party's listening volume. If the volume is not loud enough for the other party, use this function.

● Select Far-End VOL.

Refer to *Introduction of Bluetooth telephone operations* on page 38.

1 2 3

- This function can be performed even while talking on the phone.
- Settings can be stored for each device.

Switching the ring tone

You can select whether or not to use this unit's ring tone. If this function is set to on, the ring tone for this unit will sound.

1 Connect your cellular phone to this unit.

2 Turn ring tone on or off.

Refer to *Introduction of Bluetooth telephone operations* on page 38.

Using the preset dial lists

You can easily store up to six phone numbers as presets.

1 Display the preset screen.

Refer to *Introduction of Bluetooth telephone operations* on page 38.

2 Touch one of preset dial keys to select the desired phone number.

- If you want to delete a preset phone number, touch and hold the preset dial key.

3 Make the call.

Refer to *Introduction of Bluetooth telephone operations* on page 38.

4 End the call.

Refer to *Introduction of Bluetooth telephone operations* on page 38.

Detailed instructions

Making a call by entering phone number



Important

Be sure to park your vehicle in a safe place and apply the parking brake when performing this operation.

1 Switch to the entering phone number mode.

Refer to *Introduction of Bluetooth telephone operations* on page 38.

2 Touch the number icons to input the numbers.

- Up to 24 digits can be entered.

3 Make the call.

Refer to *Introduction of Bluetooth telephone operations* on page 38.

4 End the call.

Refer to *Introduction of Bluetooth telephone operations* on page 38.

Note

Entering phone number mode cannot be operated unless a Bluetooth telephone is connected to this unit. 

Setting the private mode

During a conversation, you can switch to private mode (talk directly on your cellular phone).

Refer to *Introduction of Bluetooth telephone operations* on page 38. 

Introduction of menu operations

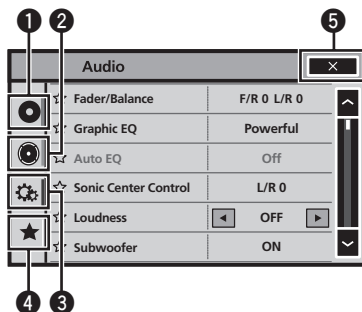

- You cannot display the Audio function menu when the mute function is on or a JPEG file is playing.

1 Display menus.

Refer to *Basic operations* on page 14.

2 Touch any of the following touch panel keys to select the menu to be adjusted.

Touch panel keys

1		Video Setup menu Refer to <i>Setting up the Video player</i> on page 60.
2		Audio function menu Refer to <i>Audio adjustments</i> on the next page.
3		System menu Refer to <i>System settings</i> on page 64.
4		Favorite menu You can choose menus with in each menu (Audio function menu, etc.) and register them to this favorite menu. Refer to <i>Favorite menu</i> on page 70.
5		Returning to the current source display

Notes

- You can display the **Video Setup** menu when a **Disc**, **USB** or **SD** source is selected.
- If you start the **Video Setup** menu, playback is stopped.

Menu operations

Audio adjustments

Using fader/balance adjustment

You can change the fader/balance setting to provide an ideal listening environment for all of the occupied seats.

1 Display the audio function menu.

Refer to *Introduction of menu operations* on the previous page.

2 Touch Fader/Balance on the audio function menu.

3 Touch ▲ or ▼ to adjust the front/rear speaker balance.

Range: **Front 15** to **Rear 15**

- Select **F/R 0 L/R 0** when only using two speakers.
- The front/rear speaker balance cannot be adjusted when the rear output setting is **Subwoofer**. Refer to *Setting the rear output and subwoofer controller* on page 64.

4 Touch ◀ or ▶ to adjust the left/right speaker balance.

Range: **Left 15** to **Right 15**

Note

You can also set the fader/balance by dragging the dot on the displayed table.

Using the equalizer

You can adjust the equalization to match the car's interior acoustic characteristics as desired.

Recalling equalizer curves

There are seven stored equalizer curves which you can easily recall at any time. Here is a list of the equalizer curves.

Display	Equalizer curve
Powerful	Powerful
Natural	Natural
Vocal	Vocal

Display	Equalizer curve
Flat	Flat
Custom1	Custom 1
Custom2	Custom 2
S.Bass	Super bass

- The equalizer curves for **Custom1** and **Custom2** can be adjusted.
- You cannot select **Custom1** and **Custom2** when using the auto equalizer.
- When **Flat**, no changes are made to the sound. You can check the effects of the equalizer curves by switching alternatively between **Flat** and another equalizer curve.

1 Display the audio function menu.

Refer to *Introduction of menu operations* on the previous page.

2 Touch Graphic EQ on the audio function menu.

- You cannot select or adjust the equalizer curves of **Custom1** and **Custom2** when using the auto equalizer.

3 Touch the desired setting.

S.Bass Powerful Natural Vocal Flat Custom1 Custom2

Adjusting the 8-band graphic equalizer

You can adjust the level of each band for the equalizer curves.

- A separate **Custom1** curve can be created for each source. If you make adjustments when a curve other than **Custom2** is selected, the equalizer curve settings will be stored in **Custom1**.
- A **Custom2** curve that is common for all sources can be created. If you make adjustments when the **Custom2** curve is selected, the **Custom2** curve will be updated.

1 Display the audio function menu.

Refer to *Introduction of menu operations* on the previous page.

2 Touch Graphic EQ on the audio function menu.

3 Touch the desired setting.

S.Bass Powerful Natural Vocal Flat Custom1 Custom2

4 Touch the table to adjust the level of the equalizer band.

Range: **+12dB** to **-12dB**

Using the auto-equalizer

The auto equalizer is an equalizer curve created by auto EQ (refer to *Auto EQ (auto equalizing)* on page 68).

You can turn the auto equalizer on or off.

If you connect an optional microphone to this unit, you can use this function.

1 Display the audio function menu.

Refer to *Introduction of menu operations* on page 56.

2 Touch Auto EQ to turn the auto-equalizer on or off.

- You cannot use this function if auto EQ has not been carried out.

Using sonic center control

Sound that is suited for the listening position can easily be created with this function.

1 Display the audio function menu.

Refer to *Introduction of menu operations* on page 56.

2 Touch Sonic Center Control on the audio function menu.

3 Touch ◀ or ▶ to select a listening position.

Range: **Left 7** to **Right 7**

Adjusting loudness

Loudness compensates for deficiencies in the low frequency and high frequency ranges at low volume.

1 Display the audio function menu.

Refer to *Introduction of menu operations* on page 56.

2 Touch ◀ or ▶ to select a desired level for loudness.

Off (off) **Low** (low) **Mid** (mid) **High** (high)

Using subwoofer output

This unit is equipped with a subwoofer output which can be turned on or off.

- The cut off frequency and output level can be adjusted when the subwoofer output is on.

1 Display the audio function menu.

Refer to *Introduction of menu operations* on page 56.

2 Touch Subwoofer on the audio function menu.

3 Touch On or Off next to Subwoofer to turn the subwoofer output on or off.

4 Touch Normal or Reverse next to Phase to select the phase of subwoofer output.

5 Touch ◀ or ▶ next to Level to adjust the output level of the subwoofer.

Range: **+6** to **-24**

6 Touch ◀ or ▶ next to Frequency to select the cut-off frequency.

50Hz 63Hz 80Hz 100Hz 125Hz

Only frequencies lower than those in the selected range are outputted from the subwoofer.

Boosting the bass

You can boost the bass level.

Menu operations

1 Display the audio function menu.

Refer to *Introduction of menu operations* on page 56.

2 Touch ◀ or ▶ to select a desired level.

Range: 0 to +6

Using the high pass filter

When you do not want low sounds from the subwoofer output frequency range to play from the front or rear speakers, turn on the HPF (high pass filter). Only frequencies higher than those in the selected range are output from the front or rear speakers.

1 Display the audio function menu.

Refer to *Introduction of menu operations* on page 56.

2 Touch ◀ or ▶ next to the frequency to select cut-off frequency.

Off (off) 50Hz 63Hz 80Hz 100Hz
125Hz

Only frequencies higher than those in the selected range are output from the front or rear speakers.

Adjusting source levels

With SLA (source level adjustment), the volume levels of each source can be adjusted to prevent significant differences between sources.

- Settings are based on the FM volume level, which remains unchanged.

1 Display the audio function menu.

Refer to *Introduction of menu operations* on page 56.

2 Compare the FM volume level with the level of the source you wish to adjust.

3 Touch Source Level Adjuster on the audio function menu.

4 Touch ▲ or ▼ to adjust the source volume.

Range: +4 to -4

Notes

- When selecting FM as the source, you cannot switch to **Source Level Adjuster**.
- The AM volume level can also be adjusted with this function.
- Video CD, CD, compressed audio, DivX, MPEG 1, MPEG 2 and MPEG 4 are automatically set to the same source level adjustment volume.
- When an iPod and a USB storage device are connected to USB input 1 or USB input 2, the source level adjustment volume for each is automatically set to the same level for each USB input. USB input 1 and USB input 2 are not automatically set to the same setting.
- External unit 1 and external unit 2 are automatically set to the same source level adjustment volume. 

Setting up the Video player

Setting the subtitle language

You can set a desired subtitle language. When available, the subtitles will be displayed in the selected language.

1 Display the Video Setup menu.

Refer to *Introduction of menu operations* on page 56.

2 Touch Subtitle Language on the Video Setup menu.

A subtitle language menu is displayed.

3 Touch the desired language.

The subtitle language is set.

- If you have selected **Others**, refer to *When you select Others* on this page.

Notes

- If the selected language is not available, the language specified on the disc is displayed.
- You can also switch the subtitle language by touching the icon during playback. (Refer to *Playing moving images* on page 24.)
- The setting made here will not be affected even if the subtitle language is switched during playback using **Subtitle**.

When you select Others

A language code input display is shown when **Others** is selected. Refer to *Language code chart for DVD* on page 110.

● Touch 0 to 9 to input the language code.

- To cancel the entered numbers, touch **C**.
- To register the code, touch the following touch panel key.



Registering the code.

Setting the audio language

You can set the preferred audio language.

1 Display the Video Setup menu.

Refer to *Introduction of menu operations* on page 56.

2 Touch Audio Language on the Video Setup menu.

An audio language menu is displayed.

3 Touch the desired language.

The audio language is set.

- If you have selected **Others**, refer to *When you select Others* on this page.

Notes

- If the selected language is not available, the language specified on the disc is used.
- You can also switch the audio language by touching **Audio** during playback. (Refer to *Playing moving images* on page 24.)
- The setting made here will not be affected even if the audio language is switched during playback using **Audio**.

Setting the menu language

You can set the preferred language in which the menus recorded on a disc are displayed.

1 Display the Video Setup menu.

Refer to *Introduction of menu operations* on page 56.

2 Touch Menu Language on the Video Setup menu.

A menu language menu is displayed.

3 Touch the desired language.

The menu language is set.

- If you have selected **Others**, refer to *When you select Others* on this page.

Note

If the selected language is not available, the language specified on the disc is displayed.

Setting the multi-angle DVD display

The angle icon can be set so it appears on scenes where the angle can be switched.

Menu operations

1 Display the Video Setup menu.

Refer to *Introduction of menu operations* on page 56.

2 Touch Multi Angle on the Video Setup menu to turn angle icon display on or off.

Setting the aspect ratio

There are two kinds of display: a wide screen display that has a width to height ratio (TV aspect ratio) of 16:9, and regular display that has a TV aspect of 4:3. Be sure to select the correct TV aspect for the display connected to **V OUT**.

- When using regular display, select either **Letter Box** or **Pan Scan**. Selecting **16:9** may result in an unnatural picture.
- If you select the TV aspect ratio, the unit's display will change to the same setting.

1 Display the Video Setup menu.

Refer to *Introduction of menu operations* on page 56.

2 Touch TV Aspect on the Video Setup menu to select the TV aspect ratio.

Touch **TV Aspect** repeatedly until the desired aspect ratio appears.

- **16:9** Wide screen picture (16:9) is displayed as is (initial setting)
- **Letter Box** The picture is the shape of a letterbox with black bands on the top and bottom of the screen
- **Pan Scan** The picture is cut short on the right and left sides of the screen

Notes

- When playing discs that do not specify **Pan Scan**, the disc is played back in **Letter Box** display even if you select the **Pan Scan** setting. Confirm whether the disc package bears the **16:9 LB** mark.
- The TV aspect ratio cannot be changed for some discs. For details, refer to the disc's instructions.

Setting the slideshow interval

JPEG files can be viewed as a slideshow on this unit. In this setting, the interval between each image can be set.

1 Display the Video Setup menu.

Refer to *Introduction of menu operations* on page 56.

2 Touch Time Per Photo Slide on the Video Setup menu to select the slideshow interval.

Touch **Time Per Photo Slide** repeatedly until the desired setting appears.

- **5sec** JPEG images switch at intervals of 5 seconds
- **10sec** JPEG images switch at intervals of 10 seconds
- **15sec** JPEG images switch at intervals of 15 seconds
- **Manual** JPEG images can be switched manually

Setting parental lock

Some DVD video discs let you use parental lock to restrict children from viewing violent and adult oriented scenes. You can set parental lock to the desired level.

- When you have a parental lock level set and play a disc featuring parental lock, code number input indications may be displayed. In such cases, playback will begin when the correct code number is entered.

Setting the code number and level

A code number must be registered in order to play back discs with parental lock.

1 Display the Video Setup menu.

Refer to *Introduction of menu operations* on page 56.

2 Touch Parental on the Video Setup menu.

3 Touch 0 to 9 to input a four digit code number.

- To cancel the entered numbers, touch **C**.

Menu operations

- To register the code, touch the following touch panel key.



Registering the code.

The code number is set, and the level can now be set.

4 Touch 1 to 8 to select the desired level.

5 Touch Enter.

The parental lock level is set.

- **8** Playback of the entire disc is possible (initial setting)
- **7 to 2** Playback of discs for children and non adult oriented discs is possible
- **1** Playback of discs for children only is possible

Notes

- We recommend to keep a record of your code number in case you forget it.
- The parental lock level is stored on the disc. Look for the level indication written on the disc package, included literature or on the disc itself. Parental lock of this unit is not possible if a parental lock level is not stored on the disc.
- With some discs, the parental lock may be active only for certain levels of scenes. The playback of those scenes will be skipped. For details, refer to the instruction manual that came with the disc.

Changing the level

You can change the set parental lock level.

1 Display the Video Setup menu.

Refer to *Introduction of menu operations* on page 56.

2 Touch Parental on the Video Setup menu.

3 Touch 0 to 9 to input the registered code number.

4 Registering the code.



Registering the code.

This sets the code number, and the level can now be changed.

- If you enter an incorrect code number, the  icon is displayed. Touch **C** and enter the correct code number.
- If you forget your code number, refer to *If you forget your code number* on this page.

5 Touch 1 to 8 to select the desired level.

6 Touch Enter.

The new parental lock level is set.

If you forget your code number

- Press **RESET**.

Setting the DivX subtitle file

You can select whether or not to display DivX external subtitles.

- The DivX subtitles will be displayed even when **Custom** is selected if no DivX external subtitle files exist.

1 Display the Video Setup menu.

Refer to *Introduction of menu operations* on page 56.

2 Touch DivX® Subtitle on the Video Setup menu to select the desired subtitle setting.

- **Original** Display the DivX subtitles
- **Custom** Display the DivX external subtitles

Notes

- Up to 42 characters can be displayed on one line. If more than 42 characters are set, the line breaks and the characters are displayed on the next line.
- Up to 126 characters can be displayed on one screen. If more than 126 characters are set, the excess characters will not be displayed.

Menu operations

Displaying the DivX® VOD registration code

In order to play DivX VOD (video on demand) contents on this unit, the unit must first be registered with a DivX VOD contents provider. For registration, generate a DivX VOD registration code and submit it to your provider.

- Keep a record of the code as you will need it when you register your unit to the DivX VOD provider.

1 Display the Video Setup menu.

Refer to *Introduction of menu operations* on page 56.

2 Touch DivX® VOD on the Video Setup menu.

Registration Code and **Deregistration Code** appear.

3 Touch Registration Code.

Your registration code is displayed.

Displaying the deregistration code

If your device is already registered, deregister it by entering the deregistration code.

1 Display the Video Setup menu.

Refer to *Introduction of menu operations* on page 56.

2 Touch DivX® VOD on the Video Setup menu.

3 Touch Deregistration Code.

- To cancel deregistration, touch **Cancel**.

4 Touch OK.

The deregistration is complete.

Automatic playback of DVDs

When a DVD disc with a DVD menu is inserted, this unit will cancel the menu automatically and start playback from the first chapter of the first title.

- Some DVDs may not operate properly. If this function is not fully operated, turn this function off and start playback.

1 Display the Video Setup menu.

Refer to *Introduction of menu operations* on page 56.

2 Touch DVD Auto Play to turn automatic playback on.

- To turn automatic playback off, touch **DVD Auto Play** again. 

System settings

Switching the auxiliary setting

Activate this setting when using an auxiliary device connected to this unit.

1 Display the system menu.

Refer to *Introduction of menu operations* on page 56.

2 Touch AUX Input on the system menu to turn AUX Input on or off.

Setting AV input

Activate this setting when using an external video component connected to this unit.

1 Display the system menu.

Refer to *Introduction of menu operations* on page 56.

2 Touch AV Input on the system menu to turn AV Input on or off.

Setting the RGB Input

You can switch the setting of RGB input.

1 Display the system menu.

Refer to *Introduction of menu operations* on page 56.

2 Touch RGB Input on the system menu to turn iPhone or NAVI.

Note

If you use Advanced App Mode, set to **iPhone**.

Setting the App sound mixing

You cannot turn on or off Mixing when this unit is playing a song of iPod.

The sound of application during Advanced App Mode can be adjusted.

Enable this setting when you want to mix the App sound with the sound from a built in source (such as the radio). The volume of the App sound can be selected from 3 levels.

1 Display the system menu.

Refer to *Introduction of menu operations* on page 56.

2 Touch App sound mixing on the System menu to select desired setting.

OFF (off) **Low** (low) **Mid** (mid) **High** (high)

Setting the rear output and subwoofer controller

This unit's rear output (rear speaker leads out put and RCA rear output) can be used for full range speaker (**Full**) or subwoofer (**Subwoofer**) connection. If you switch the rear output setting to **Subwoofer**, you can connect a rear speaker lead directly to a sub woofer without using an auxiliary amp. Initially, the unit is set for a rear full range speaker connection (**Full**).

1 Turn the unit off.

Refer to *Basic operations* on page 14.

2 Press HOME to switch to the HOME display.

3 Touch System key.

System menu is displayed.

4 Touch Rear Speaker on the system menu to switch the subwoofer output or full-range speaker.

- When no subwoofer is connected to the rear output, select **Full** (full range speaker).
- When a subwoofer is connected to the rear output, select **Subwoofer** (subwoofer).

Notes

- Even if you change this setting, there will be no output unless you turn the subwoofer output on (refer to *Using subwoofer output* on page 58).
- Both rear speaker lead outputs and RCA rear output are switched simultaneously in this setting.

Setting the Tag forwarding

The song information (tag) can be saved from the broadcasting station of HD Radio to your iPod.

Menu operations

1 Display the system menu.

Refer to *Introduction of menu operations* on page 56.

2 Touch Tag forwarding on the system menu to turn USB1 or USB2.

Switching sound muting/attenuation

Sound from this system is automatically muted or attenuated when a signal from equipment with a mute function is received.

- Sound from this system returns to normal when the muting or attenuation is canceled.

1 Display the system menu.

Refer to *Introduction of menu operations* on page 56.

2 Touch Mute/ATT until the desired setting appears.

Touch **Mute/ATT** until the desired setting appears in the display.

- **Mute** Muting
- **ATT -20dB** Attenuation (**ATT -20dB** has a stronger effect than **ATT -10dB**)
- **ATT -10dB** Attenuation
- **Off** Turns the sound muting/attenuation off

Notes

- When **Mute** is displayed, the sound is turned off and no audio adjustments can be made.
- When **ATT** is displayed, the sound is attenuated and only the volume can be adjusted. (No other audio adjustments can be made.)
- Operation returns to normal when the phone connection is ended.

Selecting the system language

The system language can be selected from ten languages.

If text information such as the title name, artist name or a comment is embedded in a European language, they can also be displayed on this unit.

- The language can be changed for the following:

System menu

Video Setup menu

Bluetooth menu

On screen display

(English and Russian only)

Multi language setting for DivX

(English and Russian only)

Language for cautions

Some operations on this unit are prohibited from use while driving or require careful attention when operated. In such cases, a caution will appear on the display. You can change the language for caution messages with this setting.

- If the embedded language and the selected language setting are not the same, text information may not display properly.
- Some characters may not be displayed properly.

1 Display the system menu.

Refer to *Introduction of menu operations* on page 56.

2 Touch System Language on the system menu to select the desired language.

3 Touch the desired language.

English (English) **Português** (Portuguese)

Español (Spanish) **Français** (French)

فارسی (Persian) **Deutsch** (German) **ไทย**

(Thai) **Русский** (Russian) **العربية** (Arabic)

עברית (Hebrew)

Setting the ever scroll

When ever scroll is set to **On**, recorded text information scrolls continuously in the display. Set to **Off** if you prefer the information to scroll just once.

1 Display the system menu.

Refer to *Introduction of menu operations* on page 56.

2 Touch Ever Scroll on the system menu to turn ever scroll on or off.

Menu operations

Setting the Bluetooth audio

You need to activate the **Bluetooth Audio** source in order to use a Bluetooth audio player.

1 Display the system menu.

Refer to *Introduction of menu operations* on page 56.

2 Touch Bluetooth Audio on the system menu to turn Bluetooth audio on or off.

Clearing Bluetooth memory

Important

Never turn the unit off while the Bluetooth memory is being cleared.

1 Turn the unit off.

Refer to *Basic operations* on page 14.

2 Press HOME to switch to the HOME display.

3 Touch System key.

System menu is displayed.

4 Touch Bluetooth Memory Clear on the system menu.

5 Touch Clear.

After selecting a desired item, a confirmation display appears. Touch **OK** to delete the memory.

- If you do not want to clear the memory, touch **Cancel**.

Updating Bluetooth connection software

This function is used to update this unit with the latest bluetooth software. For about bluetooth software and updating, refer to our web site.

Important

Never turn the unit off and never disconnect the phone while the software is being updated.

1 Turn the unit off.

Refer to *Basic operations* on page 14.

2 Press HOME to switch to the HOME display.

3 Touch System key.

System menu is displayed.

4 Touch BT Software Update.

5 Touch Start to display the data transfer mode.

- Follow the on screen instructions to finish up dating the bluetooth software.

Displaying the Bluetooth system version

If this unit fails to operate properly, you may need to consult your dealer for repair. In such cases, you may be asked to specify the system version. Perform the following procedure to check the version on this unit.

1 Turn the unit off.

Refer to *Basic operations* on page 14.

2 Press HOME to switch to the HOME display.

3 Touch System key.

System menu is displayed.

4 Touch Bluetooth Version Information to display to the version of the Bluetooth module of this unit.

Setting the rear view camera (back up camera)

CAUTION

Pioneer recommends the use of a camera which outputs mirror-reversed images.

Otherwise, the screen image will appear reversed.

This unit features a function that automatically switches to the rear view camera video (**R.C IN**) when a rear view camera is installed on your car and the shift lever is moved to the **REVERSE (R)** position. (For more details, consult your dealer.)

Menu operations

- After you set up the rear view camera setting, move the shift lever to **REVERSE (R)** and confirm that the rear view camera video is shown on the display.
- Change this setting if the display switches to the rear view camera video by error while you are driving forward.
- To stop watching the rear view camera video and return to the source display, press and hold **MUTE**.
- Touch the **RearView** source icon to display the rear view camera image while driving. Touch the source icon again to turn the rear view camera off. For details, refer to *Selecting a source using the touch panel keys* on page 15.

1 Display the system menu.

Refer to *Introduction of menu operations* on page 56.

2 Touch Camera Polarity on the system menu to select the appropriate setting.

- **Battery** When the polarity of the connected lead is positive while the shift lever is in **REVERSE (R)** position
- **Ground** When the polarity of the connected lead is negative while the shift lever is in **REVERSE (R)** position
- **Off** When a rear view camera is not connected to this unit

Note

You can also switch the rear view image by pressing the touch key, regardless of the **Camera Polarity** setting on the system menu. Refer to *Basic operations* on page 14.

Setting the video signal

When you connect this unit to an AV equipment to this unit, select the suitable video signal setting.

- As this function is initially set to **Auto**, the unit will automatically adjust the video signal setting.
- You can operate this function only for the video signal input into the AV input.

1 Display the system menu.

Refer to *Introduction of menu operations* on page 56.

2 Touch Video Signal Setting on the function menu.

Video Signal Setting items are displayed.

- **AV** Adjusts the AV video signal
- **AUX** Adjusts the AUX video signal
- **Camera** Adjusts the rear view camera video signal

3 Touch ◀ or ▶ to select the desired video signal appears.

Auto PAL NTSC PAL-M PAL-N SECAM

Setting the Artwork Dance

When a song is played by MIXTRAX, the artwork display can be moved based on the music type.

1 Display the system menu.

Refer to *Introduction of menu operations* on page 56.

2 Touch Artwork Dance setting on the system menu to turn On or Off.

Changing the picture adjustment

You can adjust the **Brightness** (brightness), **Contrast** (contrast), **Color** (color), **Hue** (hue), **Dimmer** (dimmer), and **Temperature** (temperature) for each source and rear view camera.

- You cannot adjust **Color**, **Hue** and **Contrast** for the audio source.

1 Display the system menu.

Refer to *Introduction of menu operations* on page 56.

Menu operations

2 If you are adjusting the Picture Adjustment, select the unit.

NAVI

Completing **Picture Adjustment** for the Navigation system when the RGB input setting is set to **NAVI**.

Apps

Completing **Picture Adjustment** for the Advanced App Mode when the RGB input setting is set to **iPhone**.

Rear View

Adjusting the **Picture Adjustment** for the rear view camera.

Source

Adjusting the **Picture Adjustment** for the source.

3 Touch any of the following touch panel keys to select the function to be adjusted.

Picture Adjustment items are displayed.

- **Brightness** Adjusts the black intensity
- **Contrast** Adjusts the contrast
- **Color** Adjusts the color saturation
- **Hue** Adjusts the tone of color (red or green is emphasized)
- **Dimmer** Adjusts the brightness of the display
- **Temperature** Adjusts the color temperature, resulting in a better white balance
 - You can adjust **Hue** only when the color system is set to NTSC.
 - With some rear view cameras, picture adjustment may not be possible.

4 Touch ◀ or ▶ to adjust the selected item.

Each time you touch ◀ or ▶, the level of the selected item increases or decreases.

- **Dimmer** can be adjusted from **+1** to **+48**.
- **Temperature** can be adjusted from **+3** to **-3**.

Notes

- You cannot operate this function while driving.
- Different **Brightness/Contrast/Dimmer** settings can be set for when the illumination switch is on and when it is off.

Auto EQ (auto-equalizing)

The auto equalizer automatically measures the car's interior acoustic characteristics, and then creates an auto equalizer curve based on that information.

- To perform this function, dedicated microphone (e.g. CD MC20) is required.



WARNING

As a loud tone (noise) may be emitted from the speakers when measuring the car's interior acoustic characteristics, never perform auto TA or auto EQ while driving.



CAUTION

- Thoroughly check the conditions before performing auto EQ as the speakers may be damaged if these functions are performed when:
 - The speakers are incorrectly connected. (For example, when a rear speaker is connected as a subwoofer output.)
 - A speaker is connected to a power amp delivering output higher than the speaker's maximum input power capability.
- If the microphone is placed in an unsuitable position the measurement tone may become loud and measurement may take a long time, resulting in battery drainage. Be sure to place the microphone in the specified location.

Before operating the auto EQ function

- Carry out auto EQ in as quiet a place as possible, with the car engine and air conditioning switched off. Also cut power to car phones or portable telephones in the car, or remove them from the car before carrying out auto EQ. Sounds other than the measurement tone (surrounding sounds, engine sound, telephones ringing etc.) may prevent correct measurement of the car interior acoustic characteristics.
- Be sure to carry out auto EQ using the optional microphone. Using another microphone may prevent measurement, or result in incorrect measurement of the car interior acoustic characteristics.
- In order to perform auto EQ, the front speaker must be connected.

Menu operations

- When this unit is connected to a power amp with input level control, auto EQ may not be possible if the power amp's input level is set below the standard level.
- When this unit is connected to a power amp with an LPF, turn this LPF off before performing auto EQ. Also set the cut off frequency for the built in LPF of an active sub woofer to the highest frequency.
- The distance has been calculated by computer to be the optimum delay to give accurate results for the circumstances, so please continue to use this value.
The reflected sound within the car is strong and delays occur.
The LPF on active subwoofers or external amps delay the lower sounds.
- Auto EQ changes the audio settings as follows:
 - The fader/balance settings return to the center position. (Refer to *Using fader/balance adjustment* on page 57.)
 - The equalizer curve switches to **Flat**. (Refer to *Recalling equalizer curves* on page 57.)
 - The front, center and rear speakers will automatically be adjusted to a high pass filter setting.
- Previous settings for auto EQ will be overwritten.

Performing auto EQ

1 Stop the car in a place that is quiet, close all the doors, windows and sun roof, and then turn the engine off.

If the engine is left running, engine noise may prevent correct auto EQ.

2 Fix the optional microphone in the center of the headrest of the driver's seat, facing forward.

The auto EQ may differ depending on where you place the microphone. If desired, place the microphone on the front passenger seat to carry out auto EQ.

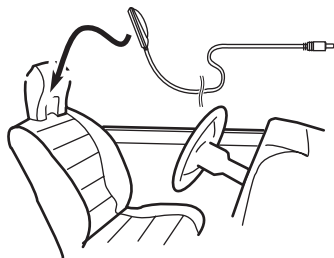

3 Turn the ignition switch to ON or ACC.

If the car's air conditioner or heater is turned on, turn it off. Noise from the fan in the air conditioner or heater may prevent correct auto EQ.

4 Display the system menu.

Refer to *Introduction of menu operations* on page 56.

5 Touch Auto EQ Measurement to enter auto EQ measurement mode.

6 Plug the microphone into the microphone input jack on this unit.

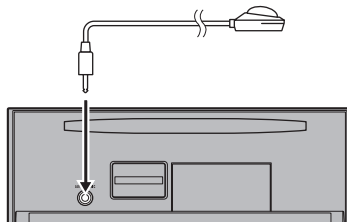

7 Touch Start to start auto EQ.

8 When the 10-second countdown starts, get out of the car and close the door within 10 seconds.

A measurement tone (noise) is emitted from the speakers, and auto EQ measurement begins.

When auto EQ is completed, **The measurement has finished. Please disconnect the microphone and then push HOME key.** is displayed.

When the car's interior acoustic characteristics cannot be measured correctly, an error message will be displayed. (Refer to *Understanding auto EQ error messages* on page 97.)

Menu operations

- It takes about nine minutes for auto EQ measurement to be completed when all the speakers are connected.

- To stop auto EQ, touch **Stop**.

9 Store the microphone carefully in the glove compartment or another safe place.

If the microphone is subjected to direct sun light for an extended period, high temperatures may cause distortion, color change or malfunction.

10 Press ▲(eject) to close the panel. 

Favorite menu

1 Display menu columns to register.

Refer to *Introduction of menu operations* on page 56.

- You can customize menus except **Video Setup** menu.

2 Touch and hold the menu column to register it.

- To cancel registration, touch and hold the menu column again.

3 Display the favorite menu and choose a registered menu.

Refer to *Introduction of menu operations* on page 56.

Note

You can register up to 12 columns. 

Menu operations

Introduction of Bluetooth connection menu operations

Refer to *Basic operations* on page 14.

If you are using a cellular phone that can be connected via Bluetooth wireless technology, we recommend that you use your phone to search for this unit and establish a connection between it and your phone. The PIN code is set to **0000** as default. The product name for this unit will display on your phone as the device name. For details, refer to *Entering PIN code for Bluetooth wireless connection* on page 73. For further details concerning the procedures for establishing Bluetooth wireless connections, refer to the instruction manual for the phone.

Pairing from this unit

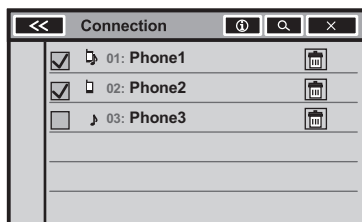

1 Display the Bluetooth Connection Menu.

Refer to *Introduction of Bluetooth telephone operations* on page 38.

2 Touch Connection to select a device.

3 Start to search.



Starting to search.

While searching,  is displayed and when available devices are found, the device names or Bluetooth device addresses (if names can not be obtained) are displayed.

- If you want to switch between the device names and Bluetooth device addresses, touch the icon.



Switching between the device names and Bluetooth device addresses.

- To cancel searching, touch **Stop**.
- If three devices are already paired, **Memory Full** is displayed and pairing cannot be performed. In such cases, delete a paired device first. Refer to this page.
- If no device can be found, **Not Found** is displayed. In such cases, check the status of the Bluetooth device and search again.

4 Touch a device name to select the device you want to connect to.

While connecting, **Pairing** is displayed. If the connection is established, **Paired** is displayed.

- If your device support SSP (Secure Simple Pairing), 6 digit number appears on the display of this unit. Once the connection is established, this number disappears.
- If the connection fails, **Error** is displayed. In such cases, try again from the beginning.
- The PIN code is set to **0000** as the default, but can be changed. Refer to *Entering PIN code for Bluetooth wireless connection* on page 73.
- Once the connection is established, the device name is displayed. Touch the device name to disconnect.
- If you want to delete a paired Bluetooth telephone, display **Delete OK?**. Touch **Yes** to delete the device.



Deleting a paired device.

- Never turn the unit off while the paired Bluetooth telephone is being deleted.

Using a Bluetooth device to pair

If you cannot open the connection between your Bluetooth device and this unit from your Bluetooth device, you can use this function to establish a connection.

1 Display the Bluetooth Connection Menu.

Refer to *Introduction of Bluetooth telephone operations* on page 38.

2 Touch Special Device to select the special device.

- Bluetooth devices that are difficult to establish a connection with are called special devices. If your Bluetooth device is listed as a special device, select the appropriate one.

3 Touch the special device list to open the connection.

This unit is now on standby for a connection with the Bluetooth device.

- If three devices are already paired,

Memory Full is displayed and pairing cannot be performed. In such cases, delete a paired device first. Refer to the previous page.

4 Use your Bluetooth device to establish a connection.

The connection method is different depending on the Bluetooth device. Refer to the manual for your Bluetooth device to establish a connection.

While connecting, **Pair your phone** is displayed. If the connection is established, **Paired** is displayed.

- If the connection fails, **Error** is displayed. In such cases, try again from the beginning.
- You may also need to enter a PIN code into this unit. If your telephone requires a PIN code to establish a connection, look for the code on the telephone or in its accompanying documentation.
- The PIN code is set to **0000** as the default, but can be changed. Refer to *Entering PIN code for Bluetooth wireless connection* on the next page.

Connecting to a Bluetooth device automatically

If this function is set to on, a connection between your Bluetooth device and this unit will take place automatically as soon as the two devices are less than a few meters apart. Initially, this function is set to on.

1 Display the Bluetooth Connection Menu.

Refer to *Introduction of Bluetooth telephone operations* on page 38.

2 Touch Auto Connect to turn automatic connection on.

If your Bluetooth device is ready for a Bluetooth wireless connection, a connection to this unit will automatically be established.

- To turn automatic connection off, touch **Auto Connect** again.

If connection fails, "**Auto connection failed. Retry?**" appears. Touch **Yes** to reconnect.

3 Once you turn your vehicle's ACC switch on again, a connection is established automatically.

Switching visible unit

This function sets whether or not to make this unit visible to the other device.

Initially, this function is set to on.

1 Display the Bluetooth Connection Menu.

Refer to *Introduction of Bluetooth telephone operations* on page 38.

2 Touch Visibility to select visibility off.

- To turn visibility on, touch **Visibility** again.

Displaying Bluetooth Device address

This unit displays its Bluetooth device address.

1 Display the Bluetooth Connection Menu.

Refer to *Introduction of Bluetooth telephone operations* on page 38.

Menu operations

2 Touch Device Information to display device information.

The Bluetooth device address is displayed.

Entering PIN code for Bluetooth wireless connection

To connect your Bluetooth device to this unit via Bluetooth wireless technology, you need to enter a PIN code on your Bluetooth device to verify the connection. The default code is **0000**, but you can change it with this function.

1 Display the Bluetooth Connection Menu.

Refer to *Introduction of Bluetooth telephone operations* on page 38.

2 Touch PIN Code Input to select PIN Code Input.

3 Touch 0 to 9 to input pin code.

4 After inputting PIN code (up to 8 digits), store in this unit.



Storing the PIN code in this unit.



Introduction of Theme setting menu operations

Refer to *Basic operations* on page 14.

Selecting the illumination color

This unit is equipped with multiple color illumination.

Direct selection from preset illumination colors

You can select an illumination color from the color list.

1 Display the Theme menu.

Refer to *Basic operations* on page 14.

2 Touch Illumination and then touch a color on the list.

Customizing the illumination color

1 Display the Theme menu.

Refer to *Basic operations* on page 14.

2 Touch Illumination and then touch Custom.

3 Display the customizing menu.



Displaying the customizing menu.

4 Touch the color bar to customize the color.

5 Touch ◀ or ▶ to fine-tune the color.

6 Touch the icon and hold to store the customized color in the memory.

Memo

Storing the customized color in the memory.

The customized color has been stored in the memory.

The set color will be recalled from the memory the next time you touch the same icon.

Selecting the OSD (on-screen display) color

The OSD color can be changed.

1 Display the Theme menu.

Refer to *Basic operations* on page 14.

2 Touch Screen.

3 Touch one of the colors on the list.

Selecting the background display

You can switch the background that is displayed when listening to a source.

1 Display the Theme menu.

Refer to *Basic operations* on page 14.

2 Touch Background.

3 Touch the desired setting.

- If no JPEG images are stored in this unit, you cannot select photo. To store a JPEG image to this unit, refer to *Capture an image in JPEG files* on page 49.
- If you want to delete the captured JPEG image, touch and hold the key of the JPEG image.
- You can view the hidden settings by dragging/flicking the display. 

Other functions

Setting rear monitor output

The output source for the rear monitor can be switched to the following:

- **Mirror** The source on the front screen of this unit
- **Disc** The video and sound from the disc
- **USB/iPod 1** The video and sound from the USB storage device
- **SD** The video and sound from the SD card
- **AV** The video and sound from AV input
- **Off** No source

Notes

- You cannot play DivX files on the rear and front monitors at the same time.
- The port that supports the rear monitor will only be USB input 1.
- **USB/iPod 1** and **SD** are compatible DivX/MPEG 4/WMV/H.264 only.
- You cannot use this function while using MIX TRAX. If you use MIXTRAX while this function is in use, this function will turn off. 

Adjusting the response positions of the touch panels (Touch Panel Calibration)

If you feel that the touch panel keys on the screen deviate from the actual positions that respond to your touch, adjust the response positions of the touch panel. There are two adjustment methods: 4 point adjustment, in which you touch four corners of the screen; and 16 point adjustment, in which you make fine adjustments on the entire screen.

- Park your car in a safe place and use this function. Do not operate it while driving.
- Touch the screen gently for adjustment. Forcefully pressing the touch panel may damage the touch panel. Do not use a sharp pointed tool such as a ballpoint pen or mechanical pen. Doing so may damage the screen.
- If the touch panel cannot be adjusted properly, consult your local Pioneer dealer.

1 Turn the unit off.

Refer to *Basic operations* on page 14.

2 Press and hold HOME to start Touch Panel Calibration.

The 4 point touch panel adjustment screen appears. When 2 point appears at once, touch both.

3 Touch each of the arrows on the four corners of the screen.

- To cancel the adjustment, press and hold **HOME**.

4 Press HOME to complete 4-point adjustment.

Data for the adjusted position is saved.

- Do not turn off the engine while the data is being saved.

5 Press HOME to proceed to 16-point adjustment.

The 16 point touch panel adjustment screen appears.

- To cancel the adjustment, press and hold **HOME**.

6 Gently touch the center of the + mark displayed on the screen.

After you touch all the marks, the data for the adjusted position is saved.

- Do not turn off the engine while the data is being saved.

7 Press and hold HOME to complete the adjustment.

Using an AUX source

A separately sold auxiliary device such as a VCR or portable device can be connected to this unit. When connected, the auxiliary device is automatically recognized as an AUX source and is assigned to **AUX**.

About AUX connection methods

You can connect auxiliary devices to this unit.

Mini pin plug cable (AUX)

When connecting an auxiliary device using a mini plug cable

iPods and portable audio/video players can be connected to this unit via mini plug cable.

- If an iPod with video capabilities is connected to this unit via 3.5 mm plug (4 pole) cable (such as the CD V150M), you can enjoy the video contents of the connected iPod.
- A portable audio/video player can be connected by using a 3.5 mm plug (4 pole) with an RCA cable (sold separately). However, depending on the cable, a reverse connection between the red (right side audio) cable and yellow (video) cable may be required in order for the sound and video image to be reproduced correctly.

- **Insert the stereo mini plug into the AUX input jack on this unit.**

Refer to *Installation* on page 78.

Refer to *What's what* on page 11. 

Using an external unit





An external unit refers to a Pioneer product, such as those which will be available in the future. Although incompatible as a source, the basic functions of up to two external units can be controlled with this unit. When two external units are connected, the external units are automatically allocated to external unit 1 or external unit 2.

The basic operations of the external unit are explained below. The allocated functions will differ depending on the connected external unit. For details concerning these functions, refer to the owner's manual for the external unit.

Basic operations

The functions allocated to the following operations will differ depending on the connected external unit. For details concerning these

functions, refer to the owner's manual for the connected external unit.

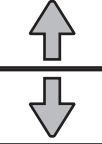
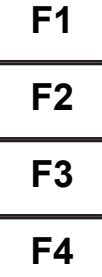
	Switching to auto or manual.
	Switching to video or audio.
	Changing the screen mode. Refer to <i>Changing the wide screen mode</i> on page 49.
	Switching the equalizer curves. Refer to <i>Using the equalizer</i> on page 57.
	Actions will differ depending on the connected external unit.
	Function 1 to 4 Actions will differ depending on the connected external unit.

Other functions**Band**

Actions will differ depending on the connected external unit.

1**2****3****4****5****6**

Actions will differ depending on the connected external unit.



Connecting the units

! WARNING

- To avoid the risk of accident and the potential violation of applicable laws, no viewing of front seat video should ever occur while the vehicle is being driven. Also, rear displays should not be in a location where they are visibly distracting to the driver.
- In some countries or states the viewing of images on a display inside a vehicle even by persons other than the driver may be illegal. Where such regulations apply, they must be obeyed and this unit's DVD features should not be used.

! CAUTION

- PIONEER does not recommend that you install or service your display unit yourself. In stalling or servicing the product may expose you to risk of electric shock or other hazards. Refer all installation and servicing of your display unit to authorized Pioneer service personnel.
- Secure all wiring with cable clamps or electrical tape. Do not allow any bare wiring to remain exposed.
- Do not drill a hole into the engine compartment to connect the yellow cable of the display unit to the vehicle battery. Engine vibration may eventually cause the insulation to fail at the point where the wire passes from the passenger compartment into the engine compartment. Take extra care in securing the wire at this point.
- It is extremely dangerous to allow the microphone lead to become wound around the steering column or shift lever. Be sure to install the unit in such a way that it will not obstruct driving.
- Make sure that cables will not interfere with moving parts of the vehicle, such as the shift lever, parking brake or seat sliding mechanism.
- Do not shorten any cables. If you do, the protection circuit may fail to work properly.

! WARNING

- LIGHT GREEN LEAD AT POWER CONNECTOR IS DESIGNED TO DETECT PARKED STATUS AND MUST BE CONNECTED TO THE POWER SUPPLY SIDE OF THE PARKING BRAKE SWITCH. IMPROPER CONNECTION OR USE OF THIS LEAD MAY VIOLATE APPLICABLE LAW AND MAY RESULT IN SERIOUS INJURY OR DAMAGE.**

! WARNING

- Use speakers over 50 W (output value) and between 4 Ω to 8 Ω (impedance value). Do not use 1 Ω to 3 Ω speakers for this unit.
- The black cable is ground. When installing this unit or power amp (sold separately), make sure to connect the ground wire first. Make sure that the ground cable is properly connected to metal parts of the car body using a spade terminal sold commercially. The ground wire of the power amp and the one of this unit or any other device must be connected to the car separately with different screws. If the screw for the ground wire loosens or falls out, it could result in fire, generation of smoke or malfunction.

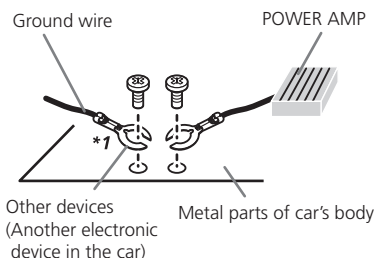

**Non supplied for this unit.*

Installation

Important

- This unit cannot be installed in a vehicle with out ACC (accessory) position on the ignition switch.



ACC position



No ACC position

- Use this unit with a 12 volt battery and negative grounding only. Failure to do so may result in a fire or malfunction.
- To prevent a short circuit, overheating or malfunction, be sure to follow the directions below.

Disconnect the negative terminal of the battery before installation.

Secure the wiring with cable clamps or adhesive tape. Wrap adhesive tape around wiring that comes into contact with metal parts to protect the wiring.

Place all cables away from moving parts, such as the shift lever and seat rails.

Place all cables away from hot places, such as near the heater outlet.

Do not connect the yellow cable to the battery by passing it through the hole to the engine compartment.

Cover any disconnected cable connectors with insulating tape.

Do not shorten any cables.

Never cut the insulation of the power cable of this unit in order to share the power with other devices. The current capacity of the cable is limited.

Use a fuse of the rating prescribed.

Never wire the negative speaker cable directly to ground.

Never band together negative cables of multiple speakers.

- When this unit is on, control signals are sent through the blue/white cable. Connect this cable to the system remote control of an external power amp or the vehicle's auto antenna relay control terminal (max. 300 mA 12 V DC). If the vehicle is equipped with a glass anten-

na, connect it to the antenna booster power supply terminal.

- Never connect the blue/white cable to the power terminal of an external power amp. Also, never connect it to the power terminal of the auto antenna. Doing so may result in battery drain or a malfunction.
- IP BUS connectors are color coded. Be sure to connect connectors of the same color.

Connecting the power cord

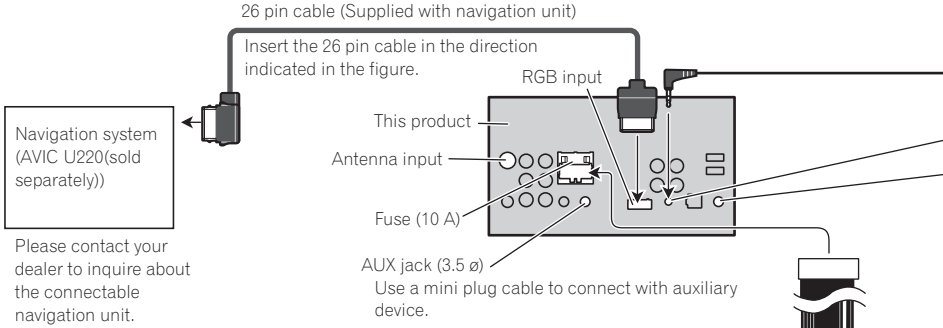

Yellow
Connect to the constant 12 V supply terminal.

Orange/white
Connect to lighting switch terminal.

Red
Connect to terminal controlled by ignition switch (12 V DC).

Black (chassis ground)
Connect to a clean, paint free metal location.

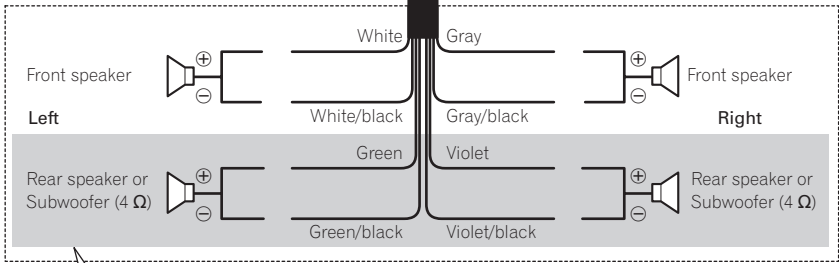

When using a subwoofer of 70 W (2 Ω), be sure to connect with Violet and Violet/black leads of this unit. Do not connect anything to Green and Green/black leads.

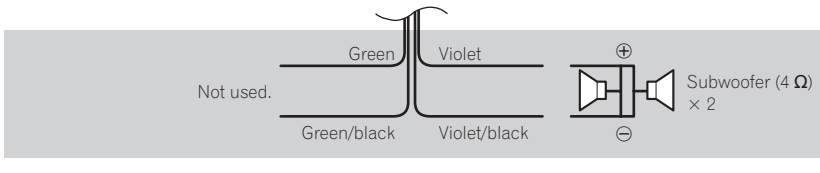

Installation

4 m (13 ft. 1 in.)



Microphone

Microphone input

Wired remote input

Hard wired remote control adaptor can be connected (sold separately).

Violet/white

Of the two lead wires connected to the back lamp, connect the one in which the voltage changes when the gear shift is in the REVERSE (R) position. This connection enables the unit to sense whether the car is moving forwards or backwards.

Yellow/black

If you use an equipment with Mute function, wire this lead to the Audio Mute lead on that equipment. If not, keep the Audio Mute lead free of any connections.

Connection method



1. Clamp the lead.

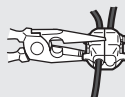

2. Clamp firmly with needle nosed pliers.

Note:

- The position of the parking brake switch depends on the vehicle model. For details, consult the vehicle Owner's Manual or dealer.

Light green

Used to detect the ON/OFF status of the parking brake. This lead must be connected to the power supply side of the parking brake switch.

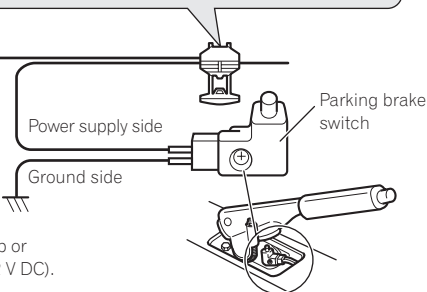

Blue/white

Connect to system control terminal of the power amp or auto antenna relay control terminal (max. 300 mA 12 V DC).

With a 2 speaker system, do not connect anything to the speaker leads that are not connected to speakers.

Note:

- Change the initial setting of this unit. The subwoofer output of this unit is monaural.

When connecting to separately sold power amp

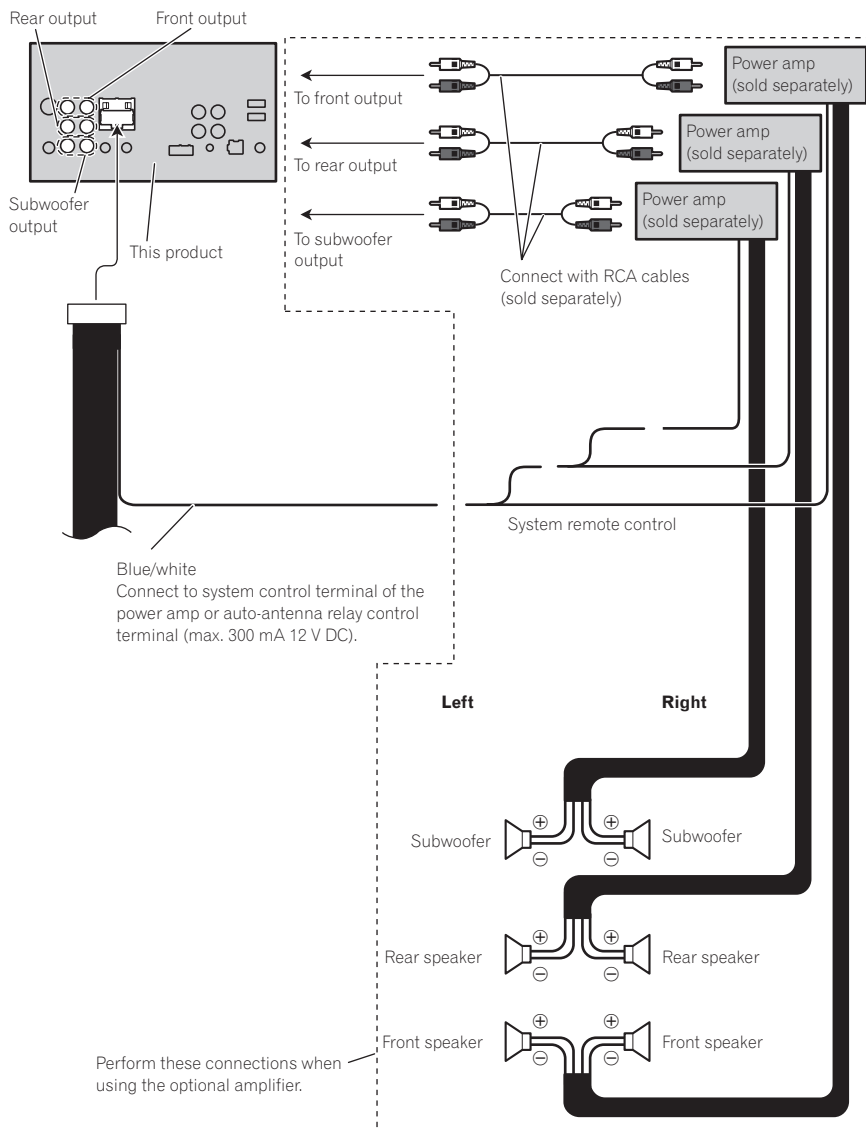

Connecting the system

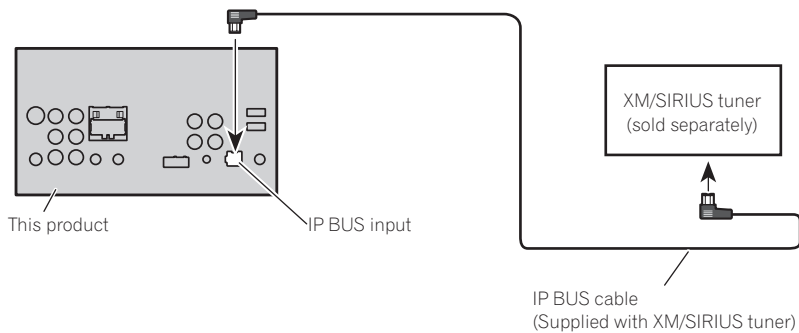

When connecting with optional CD-IU201V cable

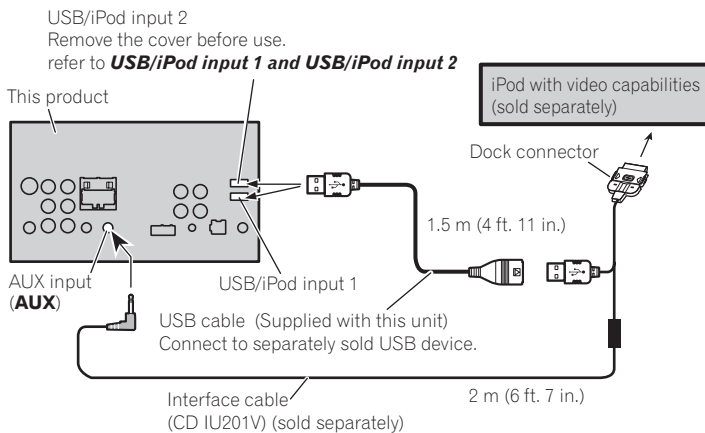

Installation

When connecting with optional CD-IU201S cable

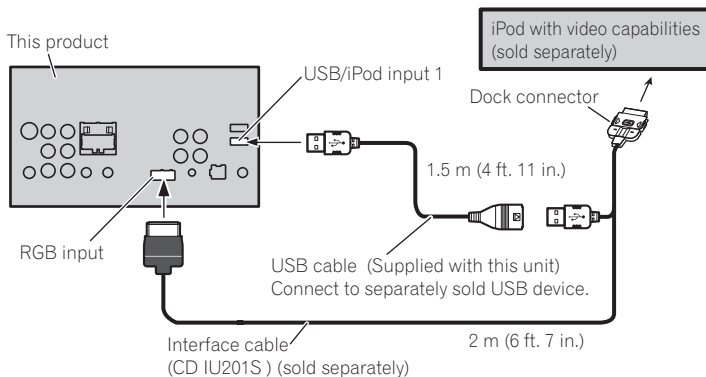

When connecting the external video component and the display

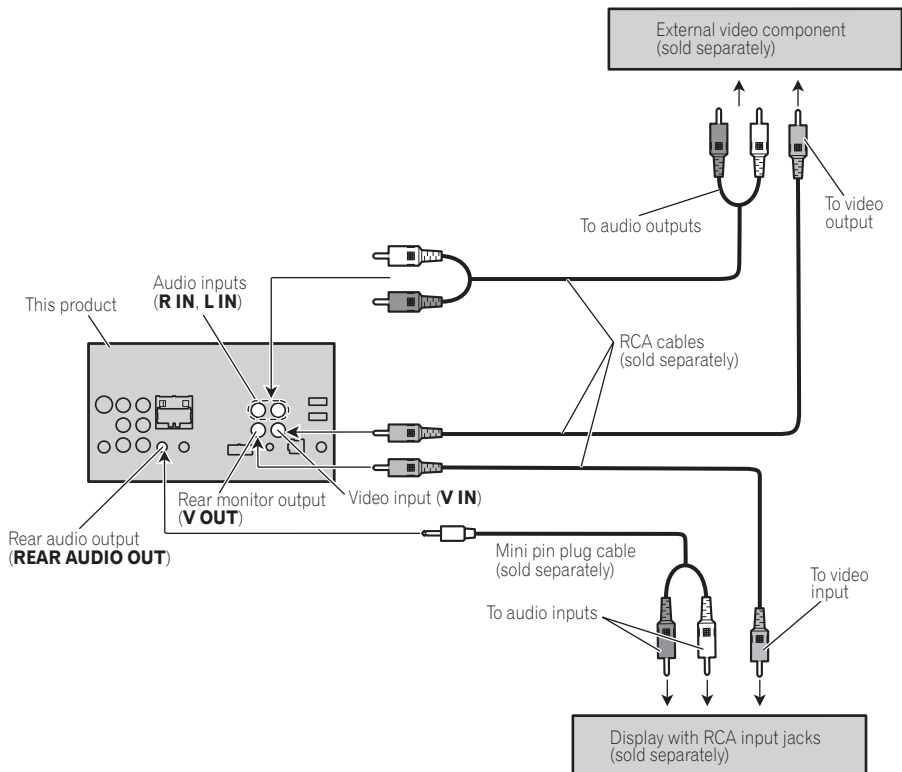

- It is necessary to change **AV Input** in the system menu when connecting the external video component.
Refer to *Setting AV input* on page 64.

When using a display connected to rear video output

This product's rear video output and rear audio output are for connection of a display to enable passengers in the rear seats to watch the DVD, etc.

! WARNING

- Never install the display in a location where it is visible to the driver while driving.

Installation

When connecting with a rear view camera

When the shift lever is switched to REVERSE (R), the display on this unit automatically switches to the rear view image. You need to set the **Camera Polarity** properly in the system menu. For details about the settings, refer to *Setting the rear view camera (back up camera)* on page 66.

You can also switch the rear view image by pressing the touch key. For details, refer to *Basic operations* on page 14.

WARNING
USE INPUT ONLY FOR REVERSE OR MIRROR IMAGE REAR VIEW CAMERA. OTHER USE MAY RESULT IN INJURY OR DAMAGE.

CAUTION

- **You must use a camera which outputs mirror reversed images.**
- The screen image may appear reversed.
- The rear view camera function is to be used as an aid to keep an eye on trailers, or while backing up. Do not use for entertainment purposes.
- Objects in the rear view may appear closer or more distant than they actually are.

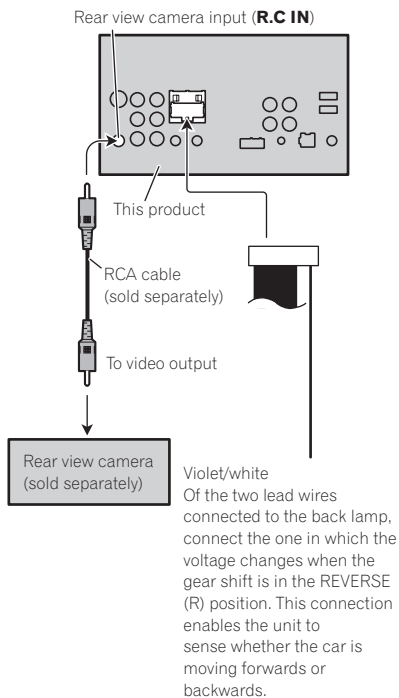

Installation

Notes

- Check all connections and systems before final installation.
- Do not use unauthorized parts as this may cause malfunctions.
- Consult your dealer if installation requires drilling of holes or other modifications to the vehicle.
- Do not install this unit where:
 - it may interfere with operation of the vehicle.
 - it may cause injury to a passenger as a result of a sudden stop.
- Do not install the display where it may (i) obstruct the driver's vision, (ii) impair the performance of any of the vehicle's operating systems or safety features, including air bags, hazard lamp buttons or (iii) impair the driver's ability to safely operate the vehicle.
- The semiconductor laser will be damaged if it overheats. Install this unit away from hot places such as near the heater outlet.
- Optimum performance is obtained when the unit is installed at an angle of less than 30°.

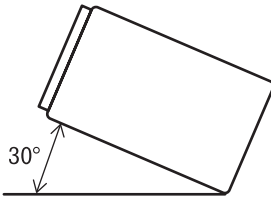

- When installing, to ensure proper heat dissipation when using this unit, make sure you leave ample space behind the rear panel and wrap any loose cables so they are not blocking the vents.

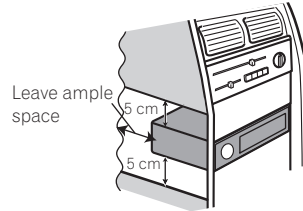

- To some types of vehicles, this unit cannot be properly installed. In such case, use the optional installation kit (ADTVA133).

Installation using the screw holes on the side of the unit

● Fastening the unit to the factory radio-mounting bracket.

Position the unit so that its screw holes are aligned with the screw holes of the bracket, and tighten the screws at 3 locations on each side.

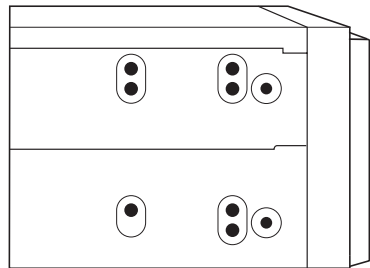

Installation

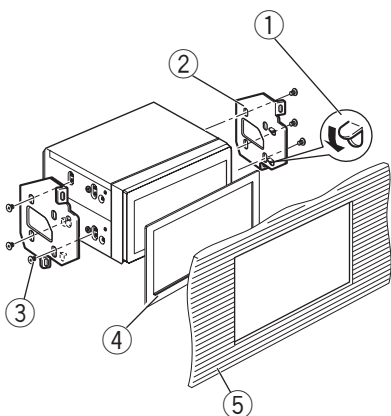

- ① If the pawl gets in the way, bend it down.
- ② Factory radio mounting bracket
- ③ Use either truss (5 mm × 8 mm) or flush surface (5 mm × 9 mm) screws, depending on the bracket screw holes.
- ④ Frame
In some types of vehicles, discrepancy may occur between the unit and the dashboard. If this happens, use the supplied frame to fill the gap.
- ⑤ Dashboard or console

Installing the microphone

⚠ CAUTION

It is extremely dangerous to allow the microphone lead to become wound around the steering column or shift lever. Be sure to install the unit in such a way that it will not obstruct driving.

Note

Install the microphone in a position and orientation that will enable it to pick up the voice of the person operating the system.

When installing the microphone on the sun visor

1 Install the microphone on the microphone clip.

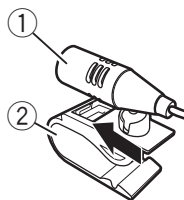

- ① Microphone
- ② Microphone clip

2 Install the microphone clip on the sun visor.

With the sun visor up, install the microphone clip. (Lowering the sun visor reduces the voice recognition rate.)

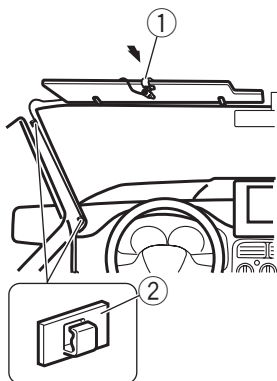

- ① Microphone clip
- ② Clamp

Use separately sold clamps to secure the lead where necessary inside the vehicle.

When installing the microphone on the steering column

1 Install the microphone on the microphone clip.

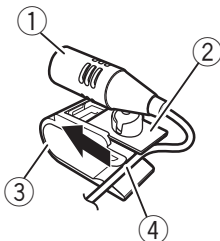

- ① Microphone
- ② Microphone base
- ③ Microphone clip
- ④ Fit the microphone lead into the groove.

Microphone can be installed without using microphone clip. In this case, detach the microphone base from the microphone clip. To detach the microphone base from the microphone clip, slide the microphone base.

2 Install the microphone clip on the rear side of the steering column.

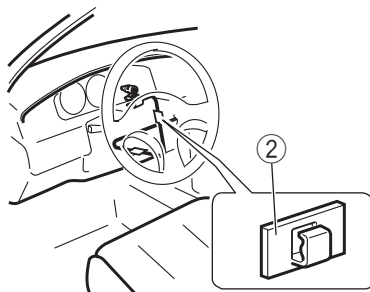
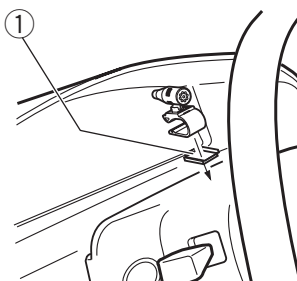

- ① Double sided tape
- ② Clamp

Use separately sold clamps to secure the lead where necessary inside the vehicle.

Adjusting the microphone angle

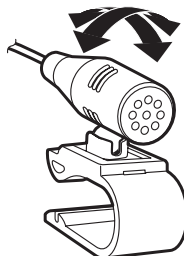

The microphone angle can be adjusted. ■

Additional information

Troubleshooting

Common

Symptom	Cause	Action (Reference page)
The power will not turn on. The unit will not operate.	Leads and connectors are incorrectly connected.	Confirm once more that all connections are correct.
	The fuse is blown.	Rectify the cause and then replace the fuse. Be sure to install a fuse with the same rating.
	Noise and/or other factors are causing the built-in microprocessor to operate incorrectly.	Press RESET . (Page 19)
Operation with the remote control is not possible. The unit does not operate correctly even when the appropriate remote control buttons are pressed.	Battery power is low.	Load a new battery.
	Some operations are prohibited with certain discs.	Try operating with another disc.
Playback is not possible.	The disc is dirty.	Clean the disc.
	The type of disc loaded cannot be played on this unit.	Check the disc type.
	The disc loaded is not compatible with this video system.	Change the disc to one that is compatible with your video system.
There is no sound. The volume level will not rise.	Cables are not connected correctly.	Connect the cables correctly.
	The unit is performing still, slow motion or frame by frame playback.	There is no sound during still, slow motion or frame by frame playback.

Symptom	Cause	Action (Reference page)
There is no image displayed.	The parking brake cable is not connected.	Connect the parking brake cable, and apply the parking brake.
	The parking brake is applied.	Connect the parking brake cable, and apply the parking brake.
The  icon is displayed, and operation is not possible.	The operation is prohibited for the disc.	This operation is not possible.
	The operation is not compatible with the configuration of the disc.	This operation is not possible.
The image displayed stops (pauses) and the unit cannot be operated.	The data could no longer be read during playback.	Stop playback once, and start playback again.
There is no sound. The volume level is low.	The volume level is low.	Adjust the volume level.
	The attenuator is on.	Turn the attenuator off.
The sound and video skip.	The unit is not firmly secured.	Firmly secure the unit.
	File size and transmission rate are above recommended rates.	Create a DivX file that is within the recommended size and transmission rate.
The aspect ratio is incorrect and the image is stretched.	The aspect ratio setting is incorrect for the display.	Select the appropriate setting for your display. (Page 61)
The motor sounds when the ignition switch is turned ON (or is turned to ACC).	The unit is confirming whether or not a disc is loaded.	This is a normal operation.

Additional information

Symptom	Cause	Action (Reference page)
Nothing is displayed. The touch panel keys cannot be used.	The rear view camera is not connected. Camera Polarity is at incorrect setting.	Connect a rear view camera. Press and hold HOME to return to the source display and then select the correct setting for Camera Polarity . (Page 67)
No xxxx appears when a display is changed (No Title , for example).	There is no embedded text information.	Switch the display or play another track/file.
Subfolders cannot be played back.	Folder repeat play has been selected.	Select the repeat range again.
The repeat range changes automatically.	Another folder was selected during repeat play. Track search or fast forward/reverse was performed during file repeat play.	Select the repeat range again. Select the repeat range again.

DVD

Symptom	Cause	Action (Reference page)
Playback is not possible.	The loaded disc has a different region number from this unit.	Replace the disc with one featuring the same region number as this unit.
A parental lock message is displayed and playback is not possible.	Parental lock is activated.	Turn parental lock off or change the level. (Page 61)
Parental lock cannot be canceled.	The code number is incorrect. You have forgotten your code number.	Enter the correct code number. (Page 61) Press RESET . (Page 19)

Symptom	Cause	Action (Reference page)
Dialog language (and subtitle language) cannot be switched.	The DVD being played does not feature multiple language recordings. You can only switch between items indicated in the disc menu.	The language cannot be switched if they are not recorded on the disc. Switch the language using the disc menu.
No subtitles are displayed.	The DVD being played does not feature subtitles. You can only switch between items indicated in the disc menu.	Subtitles are not displayed if they are not recorded on the disc. Switch the language using the disc menu.
Playback is not performed with the audio language and subtitle language settings selected in Video Setup menu.	The DVD being played does not feature dialog or subtitles in the selected language.	The language cannot be switched if the selected language is not recorded on the disc.
The viewing angle cannot be switched.	The DVD being played does not feature scenes shot from multiple angles. You are trying to switch to multi angle viewing for a scene that was not recorded from multiple angles.	The viewing angle cannot be switched if the DVD does not feature scenes recorded from multiple angles. Switch between multiple angles when watching scenes recorded from multiple angles.

Additional information

Symptom	Cause	Action (Reference page)
The image is extremely unclear/distorted and dark during playback.	Some discs feature a signal to prohibit copying.	Since this unit is compatible with the analog copy generation management system, when playing a disc that has a signal prohibiting copying, horizontal stripes or other imperfections may appear when viewed on some displays. This is not a malfunction.

Video CD

Symptom	Cause	Action
The PBC (play back control) menu cannot be called up.	The Video CD being played does not feature PBC.	This operation is not available for Video CDs that do not feature PBC.
Repeat play and track/time search are not possible.	The Video CD being played features PBC.	This operation is not available for Video CDs that feature PBC.

iPod

Symptom	Cause	Action
The iPod does not operate correctly.	The cables are not correctly connected.	Disconnect the cable from the iPod. Once the iPod's main menu is displayed, reconnect the iPod and reset it.
	The iPod version is old.	Update the iPod version.
Sound from the iPod cannot be heard.	The audio output direction may switch automatically when the Bluetooth and USB connections are used at the same time.	Use the iPod to change the audio output direction.

Bluetooth audio/telephone

Symptom	Cause	Action
The sound from the Bluetooth audio source is not played back.	There is a call in progress on a Bluetooth connected cellular phone.	The sound will be played back when the call is terminated.
	A Bluetooth connected cellular phone is currently being operated.	Do not operate the cellular phone at this time.
	A call was made with a Bluetooth connected cellular phone and then immediately terminated. As a result, communication between this unit and the cellular phone was not terminated properly.	Reconnect the Bluetooth connection between this unit and the cellular phone.

Error messages

When you contact your dealer or your nearest Pioneer Service Center, be sure to note the error message.

Tuner

Message	Cause	Action
No Data Provided	This unit cannot receive artist name/song title information.	Move to the desirable location with good reception.
No Data	This unit cannot receive program service name information.	Move to the desirable location with good reception.

DVD

Message	Cause	Action
Different Region Disc	The disc does not have the same region number as this unit.	Replace the DVD with one bearing the correct region number.

Additional information

Message	Cause	Action
Error-02-XX/ FF-FF	The disc is dirty.	Clean the disc.
	The disc is scratched.	Replace the disc.
	The disc is loaded upside down.	Check that the disc is loaded correctly.
	There is an electrical or mechanical error.	Press RESET . (Page 19)
Unplayable Disc	This type of disc cannot be played on this unit.	Replace the disc with one that can be played on this unit.
	The inserted disc does not contain any playable files.	Replace the disc.
Protect	All the files on the inserted disc are embedded with DRM.	Replace the disc.
Skipped	The inserted disc contains DRM protected files.	Play an audio file not embedded with Windows Media DRM 9/10.
TEMP	The temperature of the unit is outside the normal operating range.	Wait until the unit returns to a temperature within the normal operating limits.
This DivX rental has expired.	The inserted disc contains expired DivX VOD content.	Select a file that can be played.
Video resolution not supported	The inserted disc contains a high definition DivX/ MPEG 1/ MPEG 2/MPEG 4 file.	Select a file that can be played.
It is not possible to write it in the flash.	This unit's flash memory used as the temporary storage area is full.	Select a file that can be played.
Your device is not authorized to play this DivX protected video.	This unit's DivX registration code has not been authorized by the DivX VOD content provider.	Register this unit to the DivX VOD contents provider.

Message	Cause	Action
Unplayable File	This type of file cannot be played on this unit.	Select a file that can be played.
Format Read	Sometimes there is a delay between the start of playback and when you start to hear any sound.	Wait until the message disappears and you hear sound.
Video frame rate not supported	DivX file's frame rate is more than 30 fps.	Select a file that can be played.
Audio Format not supported	This type of file is not supported on this unit.	Select a file that can be played.

External storage device (USB, SD)

Message	Cause	Action
Unplayable File	This type of file cannot be played on this unit.	Select a file that can be played.
	There are no songs.	Transfer the audio files to the USB portable audio player/USB memory and connect.
Format Read	Security for the connected USB memory is enabled.	Follow the USB memory instructions to disable security.
	Sometimes there is a delay between the start of playback and when you start to hear any sound.	Wait until the message disappears and you hear sound.
Skipped	The connected USB portable audio player/ USB memory contains WMA files that are protected by Windows Media™ DRM 9/10.	Play an audio file not embedded with Windows Media DRM 9/10.

Additional information

Message	Cause	Action
Protect	All the files on the connected USB portable audio player/USB memory are protected by Windows Media DRM 9/10.	Transfer audio files not protected by Windows Media DRM 9/10 to the USB portable audio player/USB memory and connect.
Incompatible USB	The USB device connected to is not supported by this unit.	Connect a USB portable audio player or USB memory that is USB Mass Storage Class compliant.
	The USB device is not formatted with FAT12, FAT16 or FAT32.	The connected USB device should be formatted with FAT12, FAT16 or FAT32.
Incompatible SD	Unsupported SD card is inserted.	Use the supported SD card.
	Non compatible SD storage device	Remove your device and replace it with a compatible SD storage device.
	The SD device is not formatted with FAT12, FAT16 or FAT32.	The connected SD device should be formatted with FAT12, FAT16 or FAT32.
Check USB	The USB connector or USB cable has short circuited.	Check that the USB cable is not caught in some thing or damaged.
	The connected USB portable audio player/USB memory consumes more than maximum allowable current.	Disconnect the USB portable audio player/USB memory and do not use it. Turn the ignition switch to OFF, then to ACC or ON and then connect a compliant USB portable audio player/USB memory.

Message	Cause	Action
Error-02-9X/-DX	Communication failed.	Perform one of the following operations. Turn the ignition switch OFF and back ON. Disconnect the USB portable audio player/USB memory. Change to a different source. Then, return to the USB portable audio player/USB memory.
This DivX rental has expired.	The inserted external storage device contains expired DivX VOD content.	Select a file that can be played.
Video resolution not supported	The inserted external storage device contains a high definition DivX/MPEG 1/ MPEG 2/MPEG 4 file.	Select a file that can be played.
It is not possible to write it in the flash.	This unit's flash memory used as the temporary storage area is full.	Select a file that can be played.
Your device is not authorized to play this DivX protected video.	This unit's DivX registration code has not been authorized by the DivX VOD contents provider.	Register this unit to the DivX VOD contents provider.
Format Read	Sometimes there is a delay between the start of playback and when you start to hear any sound.	Wait until the message disappears and you hear sound.
Video frame rate not supported	DivX file's frame rate is more than 30 fps.	Select a file that can be played.
Audio Format not supported	This type of file is not supported on this unit.	Select a file that can be played.

Additional information

iPod

Message	Cause	Action
Format Read	Sometimes there is a delay between the start of playback and when you start to hear any sound.	Wait until the message disappears and you hear sound.
Error-02-6X/-9X/-DX	Communication failed.	Disconnect the cable from the iPod. Once the iPod's main menu is displayed, reconnect the iPod and reset it.
	iPod failure.	Disconnect the cable from the iPod. Once the iPod's main menu is displayed, reconnect the iPod and reset it.
Error-02-67	The iPod firmware version is old.	Update the iPod version.
Stop	There are no songs.	Transfer songs to the iPod.
	There are no songs in the current list.	Select a list that contains songs.
Not Found	No related songs.	Transfer songs to the iPod.

iTunes tagging

Message	Cause	Action
iPod full. Tags not transferred.	Memory used for tag information on the iPod is full.	Sync the iPod with iTunes and clean up the tagged playlist.
Memory full. Tags not stored. Connect iPod.	This unit's flash memory used as the temporary storage area is full.	Connect the iPod to this unit and transfer this unit's tag information to the iPod.
Tag transfer failed. Reconnect your iPod.	This unit's tag information cannot transfer to the iPod.	Check the iPod and try again.
Tag store failed.	Tag information cannot be stored in this unit.	Try again.

Message	Cause	Action
Error-8D	Built in FLASH ROM encountered an error	Turn the ignition OFF or ON.

Bluetooth

Message	Cause	Action
Error-10	The power failed for the Bluetooth module of this unit.	Turn the ignition switch OFF and then to ACC or ON. If the error message is still displayed after performing the above action, please contact your dealer or an authorized Pioneer Service Station.

Pandora

Message	Cause	Action
Error-19	Communication failed.	Disconnect the cable from the iPod. Once the iPod's main menu is displayed, reconnect the iPod and reset it.
Start up the Pandora Application from your Device.	The Pandora application has not started running yet.	Start up the Pandora application from your iPod/iPhone.
Unable to save thumb rating. Try again later.	Unable to save thumb rating.	Try again later.
Unable to save Bookmark. Try again later.	Unable to save Bookmark.	Try again later.
Pandora system maintenance. Try again later.	Pandora system is undergoing maintenance.	Try again later.
Skip limit reached.	Skip limit reached.	Do not exceed the skip limit.

Additional information

Message	Cause	Action
This version of the Pandora Application is not supported.	This version of the Pandora application is not supported.	Connect an iPod/iPhone that has a compatible version of the Pandora application installed.
Check Device	Device error message displayed in Pandora Application.	Please check your iPod/iPhone.
Pandora is unable to play music. Please see your Device.	Unable to play music from Pandora.	Please check your iPod/iPhone.
Create station within the Pandora Application on Device.	No station found.	Create a station in the Pandora application on your iPod/iPhone.
No Active Station	No station selected.	Select a station.



Message	Cause	Action
Error. Please check xxxx speaker.	The microphone cannot pick up the measuring tone of a speaker.	<ul style="list-style-type: none"> • Confirm that the speakers are connected correctly. • Correct the input level setting of the power amp connected to the speakers. • Plug the microphone securely into the jack.
Error. Please check noise.	The surrounding noise level is too high.	<ul style="list-style-type: none"> • Stop your car in a place that is quiet, and switch off the engine, air conditioner and heater. • Set the microphone correctly.
Error. Please check battery.	Power is not being supplied from the battery to this unit.	<ul style="list-style-type: none"> • Connect the battery correctly. • Check the battery voltage.



Understanding auto EQ error messages

When correct measurement of the car's interior acoustic characteristics is not possible using auto EQ, an error message may appear on the display. In such cases, refer to the table below to see what the problem is and how it may be corrected. After checking, try again.

Message	Cause	Action
Please connect the microphone for measurement. When finished, please push HOME key.	The microphone is not connected.	Plug the optional microphone securely into the jack.

Understanding messages

Messages	Translation
Screen image may appear reversed.	Pioneer recommends the use of a camera which outputs mirror-reversed images. Otherwise, the screen image will appear reversed.



Additional information

Indicator list

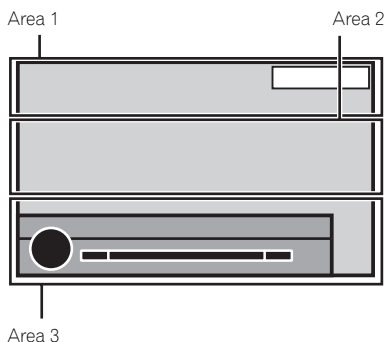

Area 1

























	Indicates that the volume is adjusted.
	Indicates that the mute function is on.
	Indicates that the sound is attenuated.

Area 2

	Shows when radio signal is received.
ANALOG	Shows when analog audio of HD Radio signal is received.
DIGITAL	Shows when digital audio of HD Radio signal is received.
HD	Shows when HD Radio station information is received.
	Shows when downloadable song information (tag) from a radio station is received.

	Shows when song information (tag) from an HD Radio station is being saved to this unit.
Dolby D	Indicates that the digital format is Dolby Digital.
MPEG-A	Indicates that the digital format is MPEG Audio.
LPCM	Indicates that the digital format is Linear PCM.
48k16	Indicates the sampling frequency.
DTS	Indicates that the digital format is DTS.
1 ch	Indicates the audio channel.
1+1ch	
2 ch	
Multi ch	
PBC On	Indicates that a disc with PBC On is being played.
	<ul style="list-style-type: none"> Indicates that a cellular phone is connected. Indicates that an incoming call has been received and has not been checked yet.

Additional information

	<p>Indicates the battery strength of the cellular phone.</p> <ul style="list-style-type: none"> The level shown on the indicator may differ from the actual battery strength. If the battery strength is not available, nothing is displayed in the battery strength indicator area. 		Shows general phone information.
	Indicates that the connected Bluetooth device supports both Bluetooth telephone and Bluetooth audio.		Shows home phone information.
	Indicates that the connected Bluetooth device only supports Bluetooth telephone.		Shows office phone information.
	Indicates that the connected Bluetooth device only supports Bluetooth audio.		Shows other phone information.
	Shows the disc title of the CD text disc currently being played.		Shows the composer name.
	Shows the song title when receiving the tag information. Shows the track title of the track currently being played for CD text discs. Shows the song title of the song currently being played for MP3/WMA/AAC files.		Shows the category name.
	Shows the comment currently being played.		Shows the folder name of the folder containing the MP3/WMA/AAC file currently being played.
	Shows the station name currently tuned in to.		Shows the file name of the MP3/WMA/AAC file currently being played.
	Shows the artist name when receiving the tag information. Shows the artist name of the track/song currently being played for CD text discs. Shows the artist name of the artist currently being played for MP3/WMA/AAC files.		Shows the preset number of the station currently being tuned in to.
	Shows cellular phone information.		Shows the channel currently being tuned in to.
			Shows SIRIUS information.
			Shows the title number currently being played.
			Shows the chapter number currently being played.
			Shows the replay time currently being played.

Additional information



Shows when the game alert function is on while receiving SIRIUS stations.



Shows the genre of the track/song currently being played.

Area 3



Touch to turn BSM on.



Indicates that Auto EQ is on.



Shows when this unit has the song information (tag).

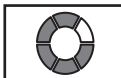

Shows while searching a song/video in alphabet search mode. Shows when song information (tag) is being saved to your iPod.



Shows when creating the database in Music browse mode.



Shows when saving the database in Music browse mode.



Indicates the signal strength of the cellular phone.



Indicates that a Bluetooth telephone is connected.



Handling guidelines

Discs and player

Use only discs featuring any of following logos.



Use 12 cm discs. Do not use 8 cm discs or an adapter for 8 cm discs.

Use only conventional, fully circular discs. Do not use shaped discs.



Do not insert anything other than a DVD R/RW or CD R/RW into the disc loading slot.

Do not use cracked, chipped, warped, or otherwise damaged discs as they may damage the player.

Unfinalized CD R/RW discs cannot be played back.

Do not touch the recorded surface of the discs.

Store discs in their cases when not in use.

Do not attach labels, write on or apply chemicals to the surface of the discs.

To clean a disc, wipe the disc with a soft cloth outward from the center.

Condensation may temporarily impair the player's performance. Let it rest for about one hour to adjust to a warmer temperature. Also, wipe any damp discs off with a soft cloth.

Playback of discs may not be possible because of disc characteristics, disc format, recorded application, playback environment, storage conditions, and so on.

Road shocks may interrupt disc playback.

Read the precautions for discs before using them.

Additional information

Certain functions may not be available for some DVD video discs.

It may not be possible to play back some DVD video discs.

It is not possible to play back DVD RAM discs.

This unit is not compatible with discs recorded in AVCHD (Advanced Video Codec High Definition) for mat. Do not insert AVCHD discs as you may not be able to eject the disc.

When using discs that can be printed on label surfaces, check the instructions and the warnings of the discs. Depending on the discs, inserting and ejecting may not be possible. Using such discs may result in damage to this equipment.

Do not attach commercially available labels or other materials to the discs.

- The discs may warp making the disc unplayable.
- The labels may come off during playback and prevent ejection of the discs, which may result in damage to the equipment.

External storage device (USB, SD)

Depending on the external storage device (USB, SD), the following problems may occur.

- Operations may vary.
- The storage device may not be recognized.
- Files may not be played back properly.

USB storage device

Connections via USB hub are not supported.

Do not connect anything other than a USB storage device.

Firmly secure the USB storage device when driving. Do not let the USB storage device fall onto the floor, where it may become jammed under the brake or accelerator pedal.

Depending on the USB storage device, the device may cause noise to occur in the radio.

Copyright protected files that are stored in the USB devices cannot be played back.

You cannot connect a USB portable audio player/USB memory to this unit via USB hub.

Partitioned USB memory is not compatible with this unit.

Depending on the kind of USB portable audio player/USB memory you use, the device may not be recognized or audio files may not be played back properly.

Do not leave the USB portable audio player/USB memory in direct sunlight for extended amounts of time. Doing so may cause the device to malfunction from the extreme rise in temperature.

SD memory card

This unit supports only the following types of SD memory cards.

- SD
- SDHC

Keep the SD memory card out of the reach of children. Should the SD memory card be swallowed, consult a doctor immediately.

Do not touch the connectors of the SD memory card directly with your fingers or with any metal device.

Do not insert anything other than an SD memory card into the SD card slot. If a metal object (such as a coin) is inserted into the slot, the internal circuits may break and cause malfunctions.

Do not insert a damaged SD memory card (e.g. warped, label peeled off) as it may not be ejected from the slot.

Do not try to force an SD memory card into the SD card slot as the card or this unit may be damaged.

When ejecting an SD memory card, press it and hold it until it clicks. It is dangerous for you to release your finger immediately after you press on the card as the card may shoot out of the slot and hit you in the face, etc. If the card shoots out of the slot, it may become lost.

iPod

To ensure proper operation, connect the dock connector cable from the iPod directly to this unit.

Firmly secure the iPod when driving. Do not let the iPod fall onto the floor, where it may become jammed under the brake or accelerator pedal.

Additional information

About iPod settings

- When an iPod is connected, this unit changes the EQ (equalizer) setting of the iPod to off in order to optimize the acoustics. When you disconnect the iPod, the EQ returns to the original setting.
- You cannot set Repeat to off on the iPod when using this unit. Repeat is automatically changed to All when the iPod is connected to this unit.

Incompatible text saved on the iPod will not be displayed by the unit.

DVD-R/RW discs

Unfinalized DVD R/RW discs which have been recorded in the Video format (video mode) cannot be played back.

Playback of DVD R/RW discs may not be possible, due to disc characteristics, scratches or dirt on the disc, or dirt, condensation, etc. on the lens of this unit.

Depending on the application settings and the environment, playback of discs recorded on a personal computer may not be possible. (For details, contact the manufacturer of the application.)

CD-R/RW discs

When CD R/RW discs are used, playback is possible only for discs which have been finalized.

Playback of CD R/RW discs recorded on a music CD recorder or a personal computer may not be possible due to disc characteristics, scratches or dirt on the disc, or dirt, condensation, etc., on the lens of this unit.

Depending on the application settings and the environment, playback of discs recorded on a personal computer may not be possible. (For details, contact the manufacturer of the application.)

Playback of CD R/RW discs may become impossible in case of direct exposure to sunlight, high temperatures, or the storage conditions in the vehicle.

Titles and other text information recorded on a CD R/RW disc may not be displayed by this unit (in the case of audio data (CD DA)).

DualDiscs

DualDiscs are two sided discs that have a recordable CD for audio on one side and a recordable DVD for video on the other.

Playback of the DVD side is possible with this unit. However, since the CD side of DualDiscs is not physically compatible with the general CD standard, it may not be possible to play the CD side with this unit.

Frequent loading and ejecting of a DualDisc may result in scratches on the disc. Serious scratches can lead to playback problems on this unit. In some cases, a DualDisc may become stuck in the disc loading slot and will not eject. To prevent this, we recommend you refrain from using DualDisc with this unit. Please refer to the information from the disc manufacturer for more detailed information about DualDiscs.

JPEG picture files

JPEG is short for Joint Photographic Experts Group and refers to a still image compression technology standard.

Files are compatible with Baseline JPEG and EXIF 2.1 still images up to a resolution of 4 092 × 4 092. (EXIF format is used most commonly with digital still cameras.)

Playback of EXIF format files that were processed by a personal computer may not be possible.

There is no progressive JPEG compatibility.

DivX video files

Depending on the composition of the file information, such as the number of audio streams or file size, there may be a slight delay when playing back discs.

Some special operations may be prohibited due to the composition of the DivX files.

Only DivX files downloaded from a DivX partner site are guaranteed for proper operation. Unauthorized DivX files may not operate properly.

DRM rental files cannot be operated until playback is started.

Recommended file size: 2 GB or less with a transmission rate of 2 Mbps or less.

The ID code of this unit must be registered to a DivX VOD provider in order to playback DivX VOD files. For information on ID codes, refer to *Displaying the DivX® VOD registration code* on page 63.

For more details about DivX, visit the following site: <http://www.divx.com/>

MPEG-1/MPEG-2/MPEG-4 video files

Elapsed playback time may not be displayed correctly.

Additional information

Important

- When naming a JPEG image file, add the corresponding file name extension (.jpg, .jpeg, .jpe or .jfif).
- This unit plays back files with these file name extensions (.jpg, .jpeg, .jpe or .jfif) as a JPEG image file. To prevent malfunctions, do not use these extensions for files other than JPEG image files. 

Compressed audio compatibility (disc, USB, SD)

WMA

File extension: .wma

Bit rate: 5 kbps to 320 kbps (CBR), VBR

Sampling frequency: 8 kHz to 48 kHz

Windows Media Audio Professional, Lossless, Voice/DRM Stream/Stream with video: Not compatible

MP3

File extension: .mp3

Bit rate: 8 kbps to 320 kbps (CBR), VBR

Sampling frequency: 8 kHz to 48 kHz (32 kHz, 44.1 kHz, 48 kHz for emphasis)

Compatible ID3 tag version: 1.0, 1.1, 2.2, 2.3 (ID3 tag Version 2.x is given priority over Version 1.x.)

M3u playlist: Not compatible

MP3i (MP3 interactive), mp3 PRO: Not compatible

AAC

Compatible format: AAC encoded by iTunes

File extension: .m4a

Sampling frequency: 8 kHz to 44.1 kHz

Bit rate: 8 kbps to 576 kbps

Apple Lossless: Not compatible

AAC file bought from the iTunes Store (.m4p file extension): Not compatible

DivX compatibility

Compatible format: DivX video format implemented in relation to DivX standards

File extensions: .avi or .divx

DivX Ultra format: Not compatible

DivX HD format: Not compatible

DivX files without video data: Not compatible

DivX plus: Not compatible

Compatible audio codec: MP2, MP3, Dolby Digital

LPCM: Compatible

Bit rate: 8 kbps to 320 kbps (CBR), VBR

Sampling frequency: 8 kHz to 48 kHz

Compatible external subtitle file extension: .srt

MPEG-1/MPEG-2/MPEG-4 video

File extensions: .mpg or .mpeg (MPEG 1/MPEG 2), .avi (MPEG 4)

Compatible audio codec: MP2 (MPEG 1/MPEG 2), MP2, MP3, Dolby Digital (MPEG 4)

H.264 (MPEG 4AVC): Compatible

LPCM: Not compatible

Bit rate: 8 kbps to 320 kbps (CBR), VBR

Sampling frequency: 8 kHz to 48 kHz

Supplemental information

Some characters in a file name (including the file extension) or a folder name may not be displayed.

This unit may not operate correctly depending on the application used to encode WMA files.

There may be a slight delay at the start of playback of audio files embedded with image data or audio files stored on an external storage device (USB/SD) that has numerous folder hierarchies.

Disc

Playable folders: up to 700

Playable files: up to 999 for CD R/RW

Playable files: up to 3 500 for DVD R/RW

Additional information

File system: ISO 9660 Level 1 and 2, Romeo, Joliet, UDF 1.02 (DVD R/RW)

Multi session playback: Compatible

Packet write data transfer: Not compatible

Regardless of the length of blank sections between the songs from the original recording, compressed audio discs play with a short pause between songs.

External storage device (USB, SD)

Playable folders: up to 3 000 (up to 700 for DivX/MPEG 1/MPEG 2/MPEG 4)

Playable files: up to 15 000

Playback of copyright protected files: Not compatible

Partitioned external storage device (USB, SD): Only the first playable partition can be played.

There is no compatibility for Multi Media Cards (MMC).

Compatibility with all SD memory cards is not guaranteed.

This unit is not compatible with SD Audio/SD Video.

CAUTION

- Pioneer accepts no responsibility for data lost on the USB memory/USB portable audio player/SD memory card even if that data is lost while using this unit.
- Pioneer cannot guarantee compatibility with all USB mass storage devices and assumes no responsibility for any loss of data on media players, smart phones, or other devices while using this product.
- Do not leave the discs/external storage device (USB, SD) or iPod in places with high temperatures. 

iPod compatibility

This unit supports only the following iPod models. Supported iPod software versions are shown below. Older versions may not be supported.

Made for

- iPod touch 4th generation (software version 5.0.1)
- iPod touch 3rd generation (software version 5.0.1)
- iPod touch 2nd generation (software version 4.2.1)
- iPod touch 1st generation (software version 3.1.3)
- iPod classic 160GB (software version 2.0.4)
- iPod classic 120GB (software version 2.0.1)
- iPod classic (software version 1.1.2)
- iPod with video (software version 1.3)
- iPod nano 6th generation (software version 1.2)
- iPod nano 5th generation (software version 1.0.2)
- iPod nano 4th generation (software version 1.0.4)
- iPod nano 3rd generation (software version 1.1.3)
- iPod nano 2nd generation (software version 1.1.3)
- iPod nano 1st generation (software version 1.3.1)
- iPhone 4S (software version 5.0.1)
- iPhone 4 (software version 5.0.1)
- iPhone 3GS (software version 5.0.1)
- iPhone 3G (software version 4.2.1)
- iPhone (software version 3.1.3)

Depending on the generation or version of the iPod, some functions may not be available.

Operations may vary depending on the software version of iPod.

When using an iPod, an iPod Dock Connector to USB Cable is required.

When you use Pioneer CD IU51V/CD IU201V interface cable, consult your dealer for details.

About the file/format compatibility, refer to the iPod manuals.

Audiobook, Podcast: Compatible

CAUTION

Pioneer accepts no responsibility for data lost on the iPod, even if that data is lost while this unit is used. 

Sequence of audio files

The user cannot assign folder numbers and specify playback sequences with this unit.

Additional information

Example of a hierarchy

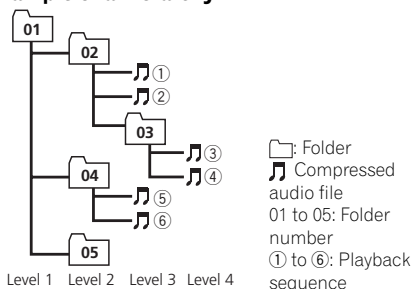

Disc

Folder selection sequence or other operation may differ depending on the encoding or writing software.

External storage device (USB, SD)

The playback sequence is the same as the recorded sequence in the external storage device (USB, SD).

To specify the playback sequence, the following method is recommended.

- ① Create a file name that includes numbers that specify the playback sequence (e.g., 001xxx.mp3 and 099yyy.mp3).
- ② Put those files into a folder.
- ③ Save the folder that contains the files to the external storage device (USB, SD).

However, depending on the system environment, you may not be able to specify the playback sequence.

For USB portable audio players, the sequence is different and depends on the player.

Using the display correctly

CAUTION

- If liquid or foreign matter should get inside this unit, turn off the power immediately and consult your dealer or the nearest authorized PIONEER Service Station. Do not use the unit in this condition because doing so may result in fire, electric shock, or other failure.
- If you notice smoke, a strange noise or smell, or any other abnormal signs from the display,

turn off the power immediately and consult your dealer or the nearest authorized PIONEER Service Station. Using this unit in this condition may result in permanent damage to the system.

- Do not disassemble or modify this unit, as there are high voltage components inside which may cause electric shock. Be sure to consult your dealer or the nearest authorized PIONEER Service Station for internal inspection, adjustments, or repairs.

Handling the display

- Never touch the screen with anything besides your finger when operating the touch panel function. The screen can scratch easily.
- When the display is subjected to direct sunlight for a long period of time, it will become very hot resulting in possible damage to the LCD screen. You should avoid exposing the display unit to direct sunlight as much as possible.
- The display should be used within the temperature range of 14 °F to 140 °F. At temperatures higher or lower than this operating temperature range, the display may not operate normally.
- The LCD screen is exposed in order to increase its visibility within the vehicle. Do not press it strongly on it as this may damage it.
- Do not push the LCD screen forcefully as this may scratch it.

Liquid crystal display (LCD) screen

- Heat from the heater may damage the LCD screen, and cool air from the cooler may cause moisture to form inside the display resulting in possible damage.
- Small black dots or white dots (bright dots) may appear on the LCD screen. These are due to the characteristics of the LCD screen and do not indicate a malfunction.

Additional information

- When using a cellular phone, keep the antenna away from the display to prevent disruption of the video image by the appearance of spots, colored stripes, etc.

LED (light-emitting diode) backlight

- At low temperatures, using the LED backlight may increase image lag and degrade the image quality due to the characteristics of the LCD screen. Image quality will improve with an increase in temperature.
- To protect the LED backlight, the display will darken in the following environments:
 - In the direct sunlight
 - Near the heater vent
- The product lifetime of the LED backlight is more than 10 000 hours. However, it may decrease if used in high temperatures.
- If the LED backlight reaches the end of its product lifetime, the screen will become dark and the image will no longer be projected. In such cases, please consult your dealer or the nearest authorized PIONEER Service Station.

Keeping the display in good condition

- When removing dust from the screen or cleaning the display, first turn the system power off, then wipe with a soft dry cloth.
- When wiping the screen, take care not to scratch the surface. Do not use harsh or abrasive chemical cleaners. 

Bluetooth profiles

In order to use Bluetooth wireless technology, devices must be able to interpret certain profiles. This unit is compatible with the following profiles.

- GAP (Generic Access Profile)
- SDP (Service Discovery Protocol)
- OPP (Object Push Profile)

- HFP (Hands Free Profile)
- HSP (Head Set Profile)
- PBAP (Phone Book Access Profile)
- A2DP (Advanced Audio Distribution Profile)
- AVRCP (Audio/Video Remote Control Profile) 1.3 

Copyright and trademark

This item incorporates copy protection technology that is protected by U.S. patents and other intellectual property rights of Rovi Corporation. Reverse engineering and disassembly are prohibited.

Bluetooth

The *Bluetooth*[®] word mark and logos are registered trademarks owned by Bluetooth SIG, Inc. and any use of such marks by PIONEER CORPORATION is under license. Other trademarks and trade names are those of their respective owners.

- Bluetooth is a short range wireless radio connectivity technology that is developed as a cable replacement for mobile phones, handheld PCs and other devices. Bluetooth operates in 2.4 GHz frequency range and transmits voice and data at speeds up to 1 megabit per second. Bluetooth was launched by a special interest group (SIG) that comprises of Ericsson Inc., Intel Corp., Nokia Corp., Toshiba and IBM in 1998, and it is currently developed by nearly 2 000 companies worldwide.

DVD video

 is a trademark of DVD Format/Logo Licensing Corporation.

iTunes

Apple and iTunes are trademarks of Apple Inc., registered in the U.S. and other countries.

Additional information

MP3

Supply of this product only conveys a license for private, non commercial use and does not convey a license nor imply any right to use this product in any commercial (i.e. revenue generating) real time broadcasting (terrestrial, satellite, cable and/or any other media), broadcasting/streaming via internet, intranets and/or other networks or in other electronic content distribution systems, such as pay audio or audio on demand applications. An independent license for such use is required. For details, please visit <http://www.mp3licensing.com>.

WMA

Windows Media is either a registered trademark or trademark of Microsoft Corporation in the United States and/or other countries. This product includes technology owned by Microsoft Corporation and cannot be used or distributed without a license from Microsoft Licensing, Inc.

SD memory card

SD Logo is a trademark of SD 3C, LLC.
SDHC Logo is a trademark of SD 3C, LLC.

iPod & iPhone

iPhone, iPod, iPod classic, iPod nano, and iPod touch are trademarks of Apple Inc., registered in the U.S. and other countries. "Made for iPod" and "Made for iPhone" mean that an electronic accessory has been designed to connect specifically to iPod or iPhone, respectively, and has been certified by the developer to meet Apple performance standards. Apple is not responsible for the operation of this device or its compliance with safety and regulatory standards. Please note that the use of this accessory with iPod or iPhone may affect wireless performance.

Dolby Digital

Manufactured under license from Dolby Laboratories. "Dolby" and the double D symbol are trademarks of Dolby Laboratories.

DivX

DivX®, DivX Certified® and associated logos are trademarks of Rovi Corporation or its subsidiaries and are used under license.

ABOUT DIVX VIDEO: DivX® is a digital video format created by DivX, LLC, a subsidiary of Rovi Corporation. This is an official DivX Certified® device that plays DivX video. Visit divx.com for more information and software tools to convert your files into DivX videos.

ABOUT DIVX VIDEO-ON-DEMAND: This DivX Certified® device must be registered in order to play purchased DivX Video on Demand (VOD) movies. To obtain your registration code, locate the DivX VOD section in *Menu operations*. Go to vod.divx.com for more information on how to complete your registration.

About the SAT RADIO READY mark



The SAT RADIO READY mark indicates that the Satellite Radio Tuner for Pioneer (i.e., XM tuner and Sirius satellite tuner which are sold separately) can be controlled by this unit. Please inquire to your dealer or nearest authorized Pioneer service station regarding the satellite radio tuner that can be connected to this unit. For satellite radio tuner operation, please refer to the satellite radio tuner owner's manual.

- Everything worth listening to is on SiriusXM, getting over 130 channels, including the most commercial free music, plus the best sports, news, talk and entertainment. A SiriusXM Vehicle Tuner and Subscription are required. For more information, visit "<http://www.siriusxm.com>"
- Sirius, XM, SAT Radio Ready and all related logos and marks are trademarks of Sirius XM Radio, Inc. All rights reserved.

Additional information

HD Radio™ Technology

- HD Radio Technology manufactured under license from iBiquity Digital Corporation. U.S. and Foreign Patents. HD Radio™ and the HD, HD Radio, and "Arc" logos are proprietary trademarks of iBiquity Digital Corp.

Pandora® internet radio

PANDORA, the PANDORA logo, and the Pandora trade dress are trademarks or registered trademarks of Pandora Media, Inc. Used with permission.

MIXTRAX

MIXTRAX is a trademark of the PIONEER CORPORATION.

libpng

Please be aware in advance that Pioneer will not respond to questions concerning the contents of the source code.

This licence was originally written in English and translated here only to help the reader understand its content. Therefore, please note that translated licence is NOT legally identified with the original English text.

This copy of the libpng notices is provided for your convenience. In case of any discrepancy between this copy and the notices in the file png.h that is included in the libpng distribution, the latter shall prevail.

COPYRIGHT NOTICE, DISCLAIMER, and LICENSE:

If you modify libpng you may insert additional notices immediately following this sentence. This code is released under the libpng license. libpng versions 1.2.6, August 15, 2004, through 1.5.0, January 6, 2011, are Copyright (c) 2004, 2006-2010 Glenn Randers Pehrson, and are distributed according to the same disclaimer and license as libpng 1.2.5 with the following individual added to the list of Contributing Authors

Cosmin Truta

libpng versions 1.0.7, July 1, 2000, through 1.2.5 October 3, 2002, are Copyright (c) 2000-2002 Glenn Randers Pehrson, and are distributed

according to the same disclaimer and license as libpng 1.0.6 with the following individuals added to the list of Contributing Authors

Simon Pierre Cadieux

Eric S. Raymond

Gilles Vollant

and with the following additions to the disclaimer:

There is no warranty against interference with your enjoyment of the library or against infringement. There is no warranty that our efforts or the library will fulfill any of your particular purposes or needs. This library is provided with all faults, and the entire risk of satisfactory quality, performance, accuracy, and effort is with the user.

libpng versions 0.97, January 1998, through 1.0.6, March 20, 2000, are Copyright (c) 1998, 1999 Glenn Randers Pehrson, and are distributed according to the same disclaimer and license as libpng 0.96, with the following individuals added to the list of Contributing Authors:

Tom Lane

Glenn Randers Pehrson

Willem van Schaik

libpng versions 0.89, June 1996, through 0.96, May 1997, are Copyright (c) 1996, 1997 Andreas Dilger Distributed according to the same disclaimer and license as libpng 0.88, with the following individuals added to the list of Contributing Authors:

John Bowler

Kevin Bracey

Sam Bushell

Magnus Holmgren

Greg Roelofs

Tom Tanner

libpng versions 0.5, May 1995, through 0.88, January 1996, are Copyright (c) 1995, 1996 Guy Eric Schalnat, Group 42, Inc.

For the purposes of this copyright and license, "Contributing Authors" is defined as the following set of individuals:

Additional information

Andreas Dilger
 Dave Martindale
 Guy Eric Schalnat
 Paul Schmidt
 Tim Wegner

The PNG Reference Library is supplied "AS IS". The Contributing Authors and Group 42, Inc. disclaim all warranties, expressed or implied, including, without limitation, the warranties of merchantability and of fitness for any purpose. The Contributing Authors and Group 42, Inc. assume no liability for direct, indirect, incidental, special, exemplary, or consequential damages, which may result from the use of the PNG Reference Library, even if advised of the possibility of such damage.

Permission is hereby granted to use, copy, modify, and distribute this source code, or portions hereof, for any purpose, without fee, subject to the following restrictions:

1. The origin of this source code must not be misrepresented.
2. Altered versions must be plainly marked as such and must not be misrepresented as being the original source.
3. This Copyright notice may not be removed or altered from any source or altered source distribution.

The Contributing Authors and Group 42, Inc. specifically permit, without fee, and encourage the use of this source code as a component to supporting the PNG file format in commercial products. If you use this source code in a product, acknowledgment is not required but would be appreciated.

A "png_get_copyright" function is available, for convenient use in "about" boxes and the like:

```
printf("%s",png_get_copyright(NULL));
```

 Also, the PNG logo (in PNG format, of course) is supplied in the files "pngbar.png" and "pngbar.jpg (88x31) and "pngnow.png" (98x31). Libpng is OSI Certified Open Source Software. OSI Certified Open Source is a certification mark of the Open Source Initiative.

Glenn Randers Pehrson
 glennrp at users.sourceforge.net
 January 6, 2011 

Additional information

Language code chart for DVD

Language (code), input code

Japanese (ja), 1001	Dzongkha (dz), 0426	Kurdish (ku), 1121	Kinyarwanda (rw), 1823
English (en), 0514	Ewe (ee), 0505	Komi (kv), 1122	Sanskrit (sa), 1901
French (fr), 0618	Esperanto (eo), 0515	Cornish (kw), 1123	Sardinian (sc), 1903
Spanish (es), 0519	Estonian (et), 0520	Kirghiz, Kyrgyz (ky), 1125	Sindhi (sd), 1904
German (de), 0405	Basque (eu), 0521	Latin (la), 1201	Northern Sami (se), 1905
Italian (it), 0920	Persian (fa), 0601	Luxembourghish (lb), 1202	Sangho (sg), 1907
Chinese (zh), 2608	Fulah (ff), 0606	Ganda (lg), 1207	Sinhala (si), 1909
Dutch, Flemish (nl), 1412	Finnish (fi), 0609	Limburgan (li), 1209	Slovak (sk), 1911
Portuguese (pt), 1620	Fijian (fj), 0610	Lingala (ln), 1214	Slovenian (sl), 1912
Swedish (sv), 1922	Faroese (fo), 0615	Lao (lo), 1215	Samoan (sm), 1913
Russian (ru), 1821	Western Frisian (fy), 0625	Lithuanian (lt), 1220	Shona (sn), 1914
Korean (ko), 1115	Irish (ga), 0701	Luba Katanga (lu), 1221	Somali (so), 1915
Greek (el), 0512	Gaelic (gd), 0704	Latvian (lv), 1222	Albanian (sq), 1917
Afar (aa), 0101	Galician (gl), 0712	Malagasy (mg), 1307	Serbian (sr), 1918
Abkhazian (ab), 0102	Guarani (gn), 0714	Marshallese (mh), 1308	Swati (ss), 1919
Avestan (ae), 0105	Gujarati (gu), 0721	Maori (mi), 1309	Sotho, Southern (st), 1920
Afrikaans (af), 0106	Manx (gv), 0722	Macedonian (mk), 1311	Sundanese (su), 1921
Akan (ak), 0111	Hausa (ha), 0801	Malayalam (ml), 1312	Swahili (sw), 1923
Amharic (am), 0113	Hebrew (he), 0805	Mongolian (mn), 1314	Tamil (ta), 2001
Aragonese (an), 0114	Hindi (hi), 0809	Marathi (mr), 1318	Telugu (te), 2005
Arabic (ar), 0118	Hiri Motu (ho), 0815	Malay (ms), 1319	Tajik (tg), 2007
Assamese (as), 0119	Croatian (hr), 0818	Maltese (mt), 1320	Thai (th), 2008
Avaric (av), 0122	Haitian (ht), 0820	Burmese (my), 1325	Tigrinya (ti), 2009
Aymara (ay), 0125	Hungarian (hu), 0821	Nauru (na), 1401	Turkmen (tk), 2011
Azerbaijani (az), 0126	Armenian (hy), 0825	Bokmal (nb), 1402	Tagalog (tl), 2012
Bashkir (ba), 0201	Herero (hz), 0826	Ndebele, North (nd), 1404	Tswana (tn), 2014
Belarusian (be), 0205	Interlingua (ia), 0901	Nepali (ne), 1405	Tonga (to), 2015
Bulgarian (bg), 0207	Indonesian (id), 0904	Ndonga (ng), 1407	Turkish (tr), 2018
Bihari (bh), 0208	Interlingue (ie), 0905	Nynorsk (nn), 1414	Tsonga (ts), 2019
Bislama (bi), 0209	Igbo (ig), 0907	Norwegian (no), 1415	Tatar (tt), 2020
Bambara (bm), 0213	Sichuan Yi (ii), 0909	Ndebele, South (nr), 1418	Twi (tw), 2023
Bengali (bn), 0214	Inupiaq (ik), 0911	Navajo, Navaho (nv), 1422	Tahitian (ty), 2025
Tibetan (bo), 0215	Ido (io), 0915	Chichewa (ny), 1425	Uighur, Uygur (ug), 2107
Breton (br), 0218	Icelandic (is), 0919	Occitan (oc), 1503	Ukrainian (uk), 2111
Bosnian (bs), 0219	Inuktitut (iu), 0921	Ojibwa (oj), 1510	Urdu (ur), 2118
Catalan (ca), 0301	Javanese (jv), 1022	Oromo (om), 1513	Uzbek (uz), 2126
Chechen (ce), 0305	Georgian (ka), 1101	Oriya (or), 1518	Venda (ve), 2205
Chamorro (ch), 0308	Kongo (kg), 1107	Ossetian (os), 1519	Vietnamese (vi), 2209
Corsican (co), 0315	Kikuyu, Gikuyu (ki), 1109	Panjabi, Punjabi (pa), 1601	Volapük (vo), 2215
Cree (cr), 0318	Kuanyama (kj), 1110	Pali (pi), 1609	Walloon (wa), 2301
Czech (cs), 0319	Kazakh (kk), 1111	Polish (pl), 1612	Wolof (wo), 2315
Church Slavonic (cu), 0321	Kalaallisut (kl), 1112	Pashto, Pushto (ps), 1619	Xhosa (xh), 2408
Chuvash (cv), 0322	Central Khmer (km), 1113	Quechua (qu), 1721	Yiddish (yi), 2509
Welsh (cy), 0325	Kannada (kn), 1114	Romansh (rm), 1813	Yoruba (yo), 2515
Danish (da), 0401	Kanuri (kr), 1118	Rundi (rn), 1814	Zhuang, Chuang (za), 2601
Divehi (dv), 0422	Kashmiri (ks), 1119	Romanian (ro), 1815	Zulu (zu), 2621



Additional information

Specifications

General

Power source	14.4 V DC (10.8 V to 15.1 V allowable)
Grounding system	Negative type
Maximum current consumption	10.0 A
Dimensions (W × H × D):	
D	

Chassis	178 mm × 100 mm × 165 mm (7 in. × 3 7/8 in. × 6 1/2 in.)
Nose	171 mm × 97 mm × 21 mm (6 3/4 in. × 3 7/8 in. × 7/8 in.)

Weight 2.1 kg (4.6 lbs)

Display

Screen size/aspect ratio	6.95 inch wide/16:9 (effective display area: 156.6 mm × 81.6 mm)
Screen size/aspect ratio	5.8 inch wide/16:9 (effective display area: 128.4 mm × 70.9 mm)
Pixels	3 072 000 (2 400 × 480)
Display method	TFT active matrix, driving type
Color system	NTSC/PAL/PAL M/PAL N/ SECAM compatible
Durable temperature range (power off)	20 °C to +80 °C

Audio

Maximum power output	50 W × 4 70 W × 1/2 Ω (for subwoofer)
Continuous power output	22 W × 4 (50 Hz to 15 000 Hz, 5% THD, 4 Ω load, both channels driven)
Load impedance	4 Ω (4 Ω to 8 Ω (2 Ω for 1 ch) allowable)
Preout maximum output level	4.0 V
Equalizer (8 Band Graphic Equalizer):	
Frequency	40 Hz/80 Hz/200 Hz/400 Hz/ 1 kHz/2.5 kHz/8 kHz/10 kHz
Gain	±12 dB
HPF:	
Frequency	50 Hz/63 Hz/80 Hz/100 Hz/ 125 Hz
Slope	12 dB/oct

Subwoofer (mono):	
Frequency	50 Hz/63 Hz/80 Hz/100 Hz/ 125 Hz
Slope	18 dB/oct
Gain	+6 dB to 24 dB
Phase	Normal/Reverse
Bass boost:	
Gain	+12 dB to 0 dB

DVD Player

System	DVD video, Video CD, CD, WMA, MP3, AAC, DivX, MPEG system
Usable discs	DVD video, Video CD, CD, CD R/RW, DVD R/RW/R DL
Region number	1
Frequency response	5 Hz to 44 000 Hz (with DVD, at sampling frequency 96 kHz)
Signal to noise ratio	96 dB (1 kHz) (IHF A net work) (RCA level)
Output level:	
Video	1.0 Vp p/75 Ω (±0.2 V)
Number of channels	2 (stereo)
MP3 decoding format	MPEG 1 & 2 Audio Layer 3
WMA decoding format	Ver. 7, 7.1, 8, 9, 10, 11, 12 (2 ch audio) (Windows Media Player)
AAC decoding format	MPEG 4 AAC (iTunes encoded only) (.m4a) (Ver. 9.0.3 and earlier)
DivX decoding format	Home Theater Ver. 3, 4, 5.2, 6 (.avi, .divx)
MPEG video decoding format	MPEG 1 (.mpg, .mpeg, .dat) MPEG 2 PS (.mpg, .mpeg) MPEG 4 Part2 (Visual), MS MPEG 4 Ver. 3 (.avi)

USB

USB standard specification	USB 1.1, USB 2.0 high speed
Maximum current supply	1.0 A
USB Class	MSC (Mass Storage Class) iPod (Audio Class, HID Class)
File system	FAT12, FAT16, FAT32
MP3 decoding format	MPEG 1 & 2 Audio Layer 3, MPEG 2.5 Audio
WMA decoding format	Ver. 7, 7.1, 8, 9, 10, 11, 12 (2 ch audio) (Windows Media Player)

Additional information

AAC decoding format MPEG 4 AAC (iTunes encoded only)
(Ver. 9.0.3 and earlier)

WAVE

WAVE signal format Linear PCM, MS ADPCM
(.wav)
Sampling Frequency ... Linear
PCM:16,22,05,24,32,44,1.48
[kHz]
MS ADPCM:22.05/44.1[kHz]

DivX

DivX decoding format
..... Home Theater Ver. 4.xx, 5.xx,
6.xx (Ultra & HD are excluded) (.avi, .divx)
Max Bit Rate 8000kbps
Max Frame Rate 30fps(In case of resolution
720×480. MAX 25fps in
case of 720×576)
Audio Codec MP2,MP3,Linear PCM /
MSAD PCM,AC 3
Decode Size MAX:720(H) × 480(W), MIN:
48(H) × 48(W)

H.264

H.264 decoding format
..... Base Line Profile (.mp4)
Max Bit Rate 8000kbps
Max Frame Rate 30fps
Audio Codec AAC
Decode Size MAX:720(H) × 1280(W),
MIN:48(H) × 48(W)

WMV

WMV decoding format
..... Main Profile (.wmv)
Max Bit Rate 8000kbps
Max Frame Rate 30fps
Audio Codec WMA
Decode Size MAX:720(H) × 1280(W),
MIN:48(H) × 48(W)

MPEG 4

MPEG 4 video decoding format
..... Simple Profile L0/L1/L2/L3,
Advanced Simple Profile
(.mp4)
Max Bit Rate 8000kbps
Max Frame Rate 30fps
Audio Codec AAC
Decode Size MAX:720(H) × 1280(W),
MIN:48(H) × 48(W)

JPEG

JPEG decoding format
..... Base Line (.jpeg, .jpg, .jpe,
.jif)
Pixel Sampling 4:2:2, 4:2:0
Decode Size MAX:4092(H) × 4092(W),
MIN:16(H) × 16(W)
Max File Size 8MByte

SD

Compatible physical format
..... Version 1.1
File system FAT12, FAT16, FAT32
MP3 decoding format MPEG 1 & 2 Audio Layer 3,
MPEG 2.5 Audio
WMA decoding format Ver. 7, 7.1, 8, 9, 10, 11, 12
(2 ch audio)
(Windows Media Player)
AAC decoding format MPEG 4 AAC (iTunes encoded only)
(Ver. 9.0.3 and earlier)

WAVE

WAVE signal format Linear PCM, MS ADPCM
(.wav)
Sampling Frequency ... Linear
PCM:16,22,05,24,32,44,1.48
[kHz]
MS ADPCM:22.05/44.1[kHz]

DivX

DivX decoding format
..... Home Theater Ver. 4.xx, 5.xx,
6.xx (Ultra & HD are excluded) (.avi, .divx)
Max Bit Rate 8000kbps
Max Frame Rate 30fps(In case of resolution
720×480. MAX 25fps in
case of 720×576)
Audio Codec MP2,MP3,Linear PCM /
MSAD PCM,AC 3
Decode Size MAX:720(H) × 480(W), MIN:
48(H) × 48(W)

H.264

H.264 decoding format
..... Base Line Profile (.mp4)
Max Bit Rate 8000kbps
Max Frame Rate 30fps
Audio Codec AAC
Decode Size MAX:720(H) × 1280(W),
MIN:48(H) × 48(W)

Additional information

WMV

WMV decoding format Main Profile (.wmv)
Max Bit Rate 8000kbps
Max Frame Rate 30fps
Audio Codec WMA
Decode Size MAX:720(H) x 1280(W), MIN:48(H) x 48(W)

MPEG 4

MPEG 4 video decoding format Simple Profile L0/L1/L2/L3, Advanced Simple Profile (.mp4)
Max Bit Rate 8000kbps
Max Frame Rate 30fps
Audio Codec AAC
Decode Size MAX:720(H) x 1280(W), MIN:48(H) x 48(W)

JPEG

JPEG decoding format Base Line (.jpeg, .jpg, .jpe, .jiff)
Pixel Sampling 4:2:2, 4:2:0
Decode Size MAX:4092(H) x 4092(W), MIN:16(H) x 16(W)
Max File Size 8MByte

FM tuner

Frequency range 87.9 MHz to 107.9 MHz
Usable sensitivity 9 dBf (0.8 μ V/75 Ω mono, S/N: 30 dB)
Signal to noise ratio 72 dB (IHF A network)

AM tuner

Frequency range 530 kHz to 1710 kHz (10 kHz)
Usable sensitivity 25 μ V (S/N: 20 dB)
Signal to noise ratio 62 dB (IHF A network)

Bluetooth

Version Bluetooth 3.0 certified
Output power +4 dBm Maximum (Power class 2)

CEA2006 Specifications



Power output 14 W RMS \times 4 Channels (4 Ω and \leq 1 % THD+N)
S/N ratio 91 dBA (reference: 1 W into 4 Ω)

Note

Specifications and the design are subject to modifications without notice. 

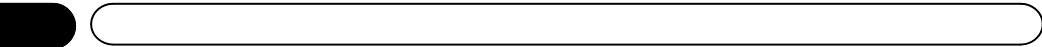

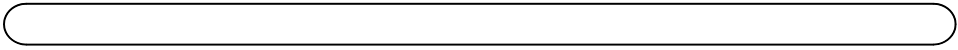

*Register your product at
Enregistrez votre produit au
Registre su producto en*

<http://www.pioneerelectronics.com>

*See "Visit our website" page
Voir la page "Visitez notre site Web"
Consulte la página sobre "Visite nuestro sitio Web"*

PIONEER CORPORATION

1-1, Shin-ogura, Saiwai-ku, Kawasaki-shi,
Kanagawa 212-0031, JAPAN

PIONEER ELECTRONICS (USA) INC.

P.O. Box 1540, Long Beach, California 90801-1540, U.S.A.
TEL: (800) 421-1404

PIONEER EUROPE NV

Haven 1087, Keetberglaan 1, B-9120 Melsele, Belgium/Belgique
TEL: (0) 3/570.05.11

PIONEER ELECTRONICS ASIACENTRE PTE. LTD.

253 Alexandra Road, #04-01, Singapore 159936
TEL: 65-6472-7555

PIONEER ELECTRONICS AUSTRALIA PTY. LTD.

5 Arco Lane, Heatherton, Victoria, 3202 Australia
TEL: (03) 9586-6300

PIONEER ELECTRONICS OF CANADA, INC.

340 Ferrier Street, Unit 2, Markham, Ontario L3R 2Z5, Canada
TEL: 1-877-283-5901
TEL: 905-479-4411

PIONEER ELECTRONICS DE MEXICO, S.A. de C.V.

Blvd.Manuel Avila Camacho 138 10 piso
Col.Lomas de Chapultepec, Mexico, D.F. 11000
TEL: 55-9178-4270

先鋒股份有限公司

台北市內湖區瑞光路407號8樓
電話：886-(0)2-2657-3588

先鋒電子（香港）有限公司

香港九龍長沙灣道909號5樓
電話：852-2848-6488

© 2012 PIONEER CORPORATION.
All rights reserved.

Printed in China

<CRB3795-A/U> UC

<KNAZX> <12A00000>